

H

1s

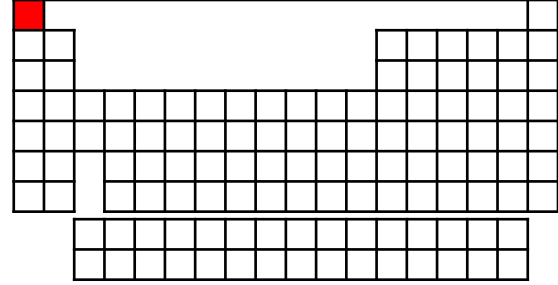

1



s

He

$1s^2$

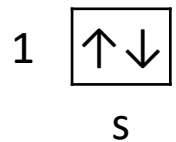
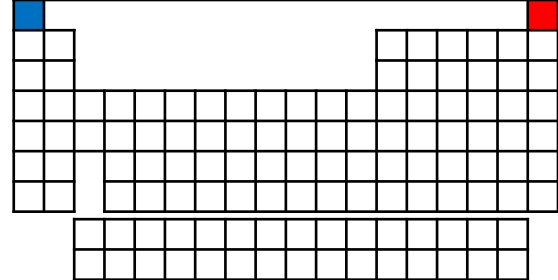

Li

[He]2s

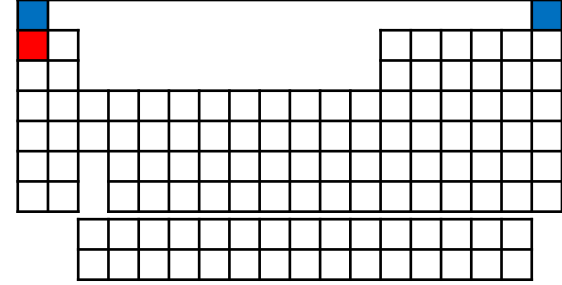

s

p

Be

[He]2s²

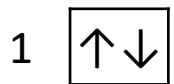
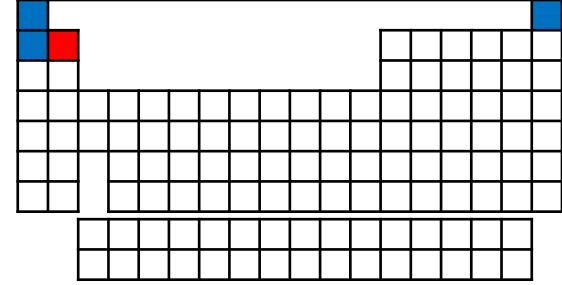

s

p

B

[He]2s²2p

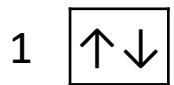
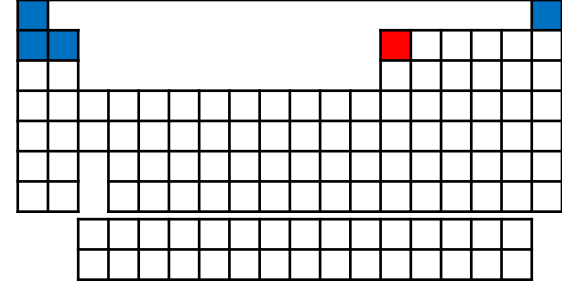

s

p

C

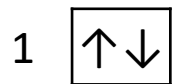
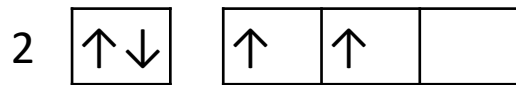
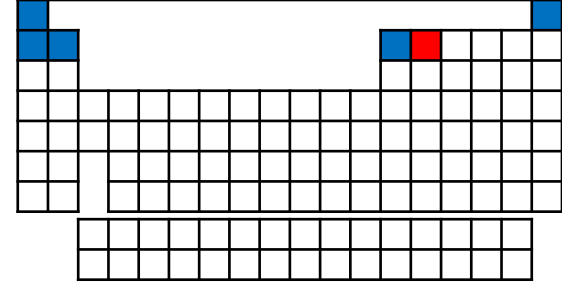
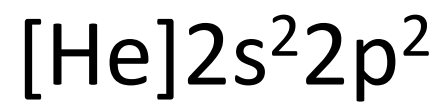

s

p

N

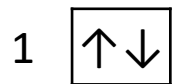
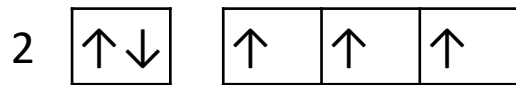
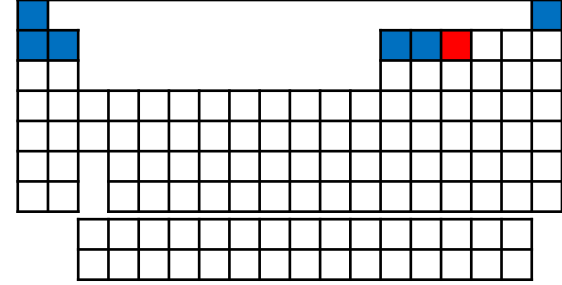
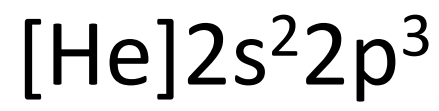

s

p

O

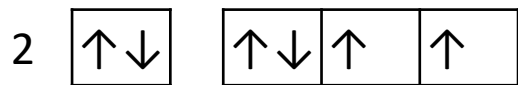
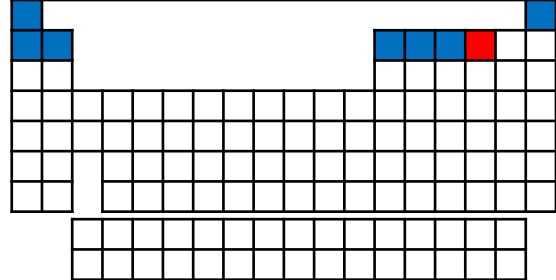
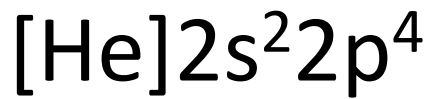

s

p

F

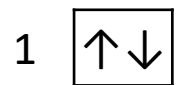
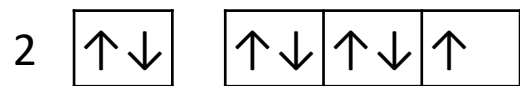
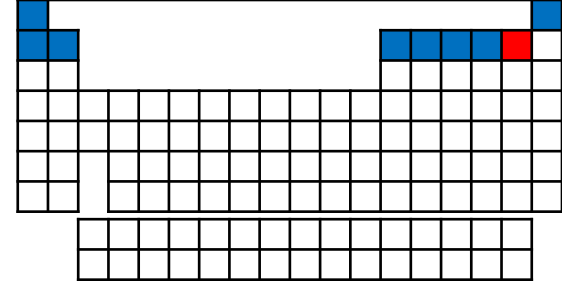
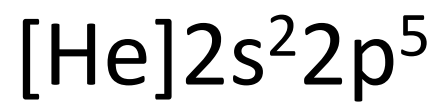

s

p

Ne

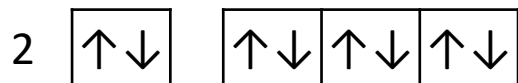
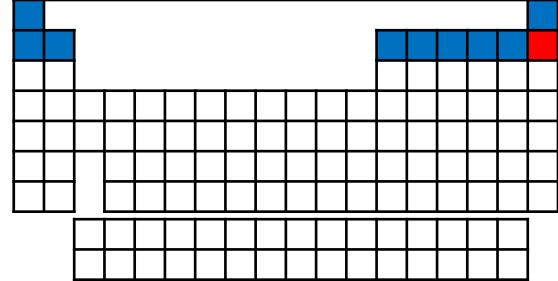
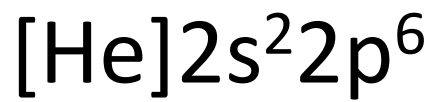

s

p

Mg

[Ne]3s²

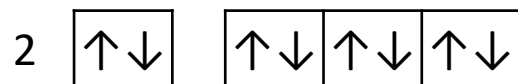
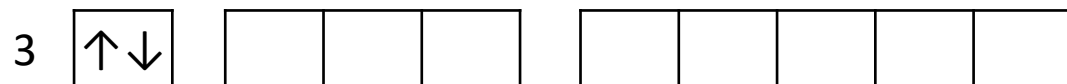
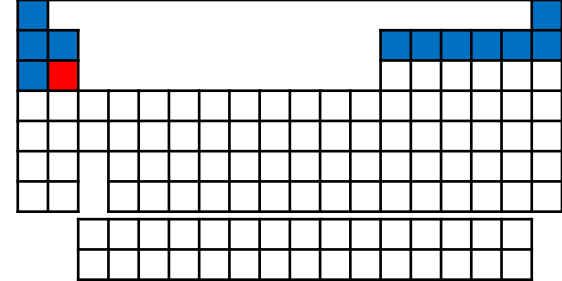

s

p

d

Al

[Ne]3s²3p

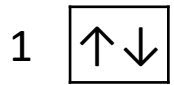
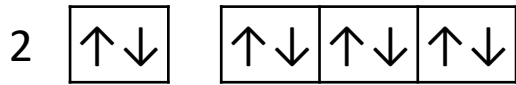
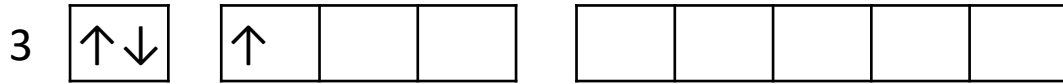
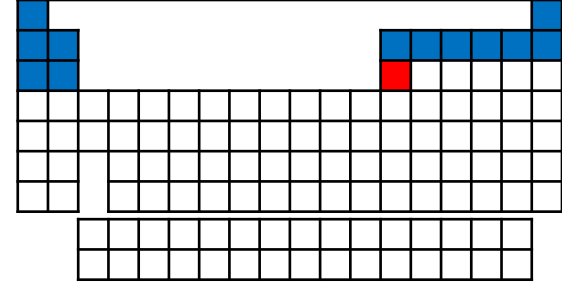

s

p

d

Si

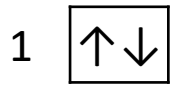
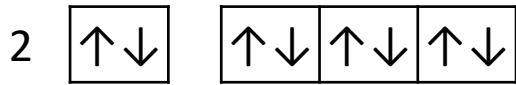
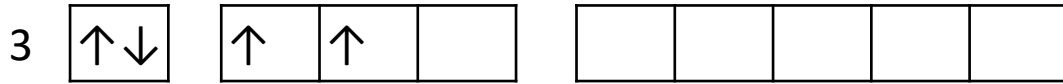
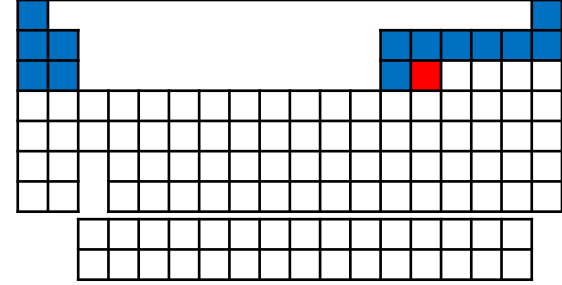
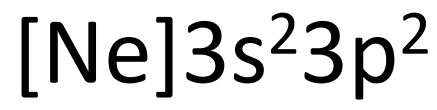

s

p

d

P

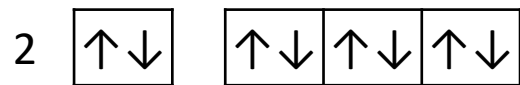
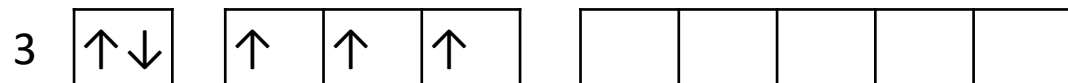
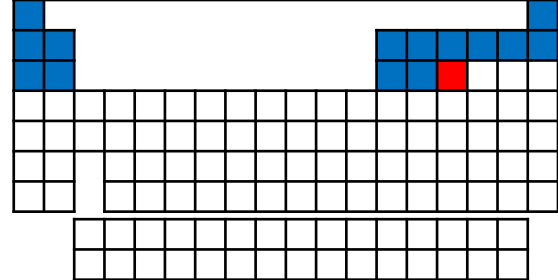
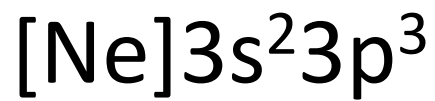

s

p

d

S

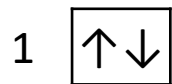
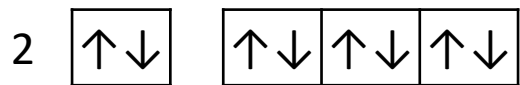
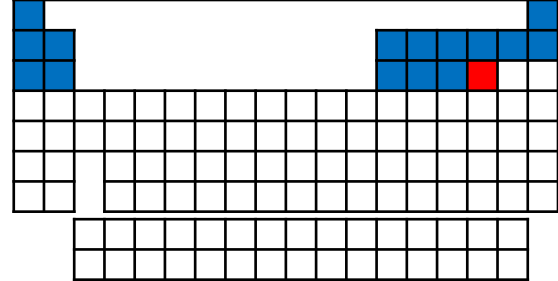
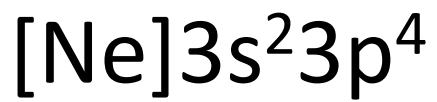

s

p

d

Cl

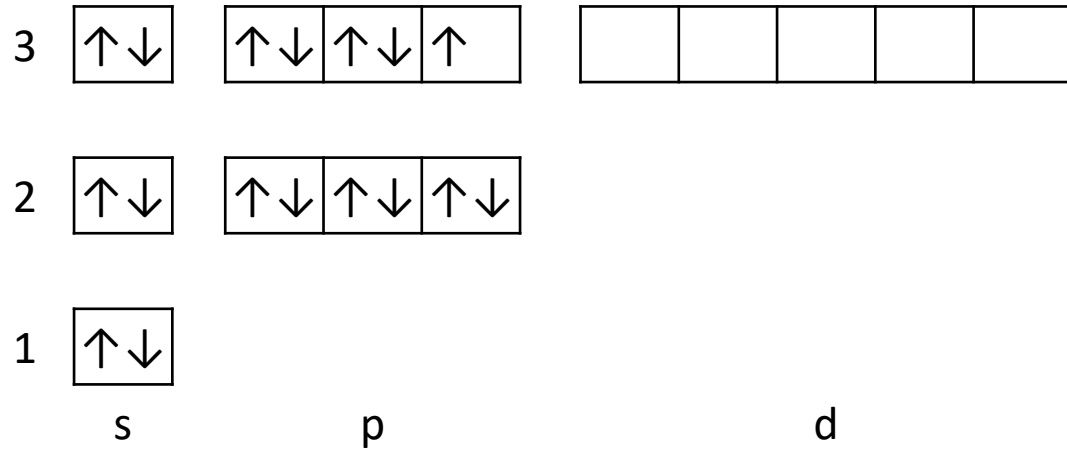
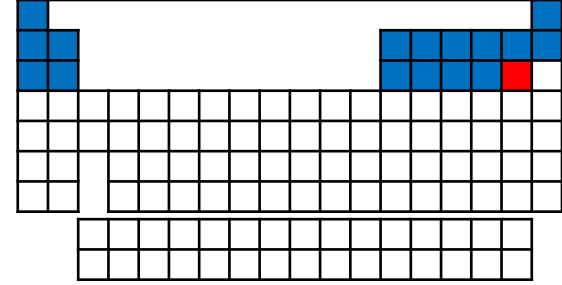
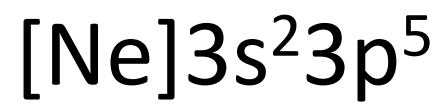

Ar

[Ne]3s²3p⁶

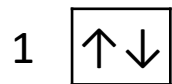
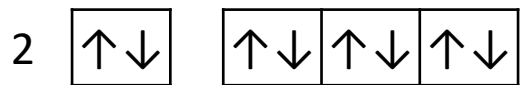
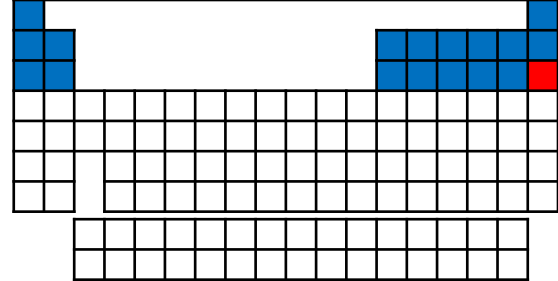

s

p

d

Ca

[Ar]4s²

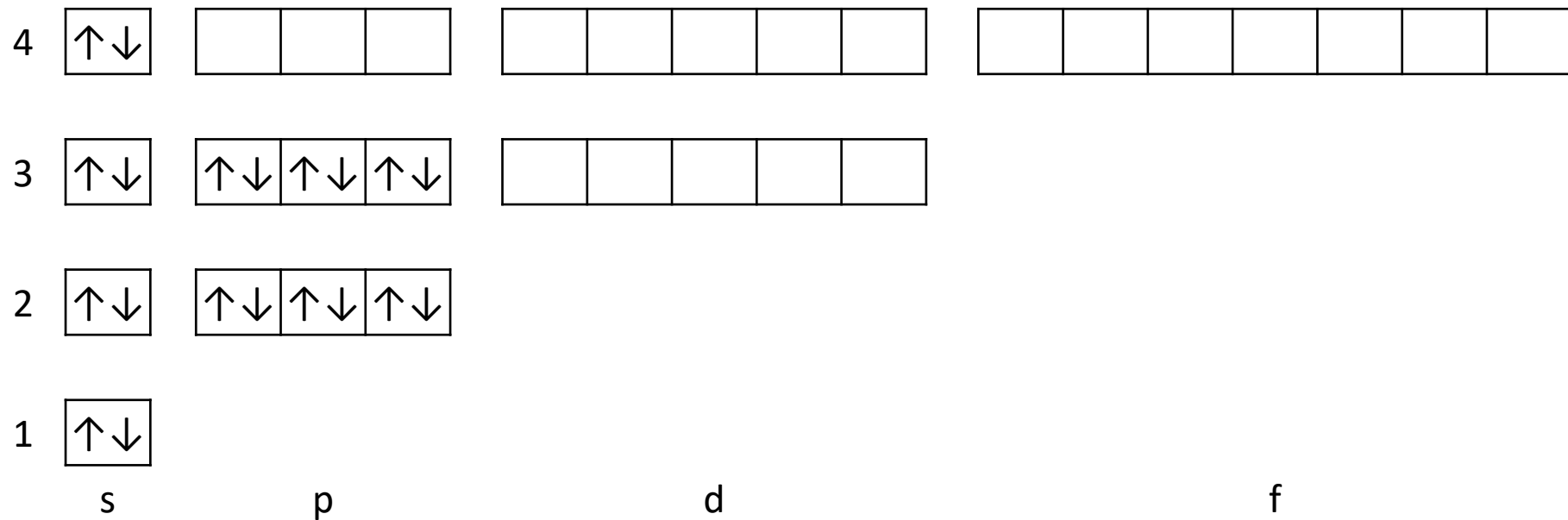
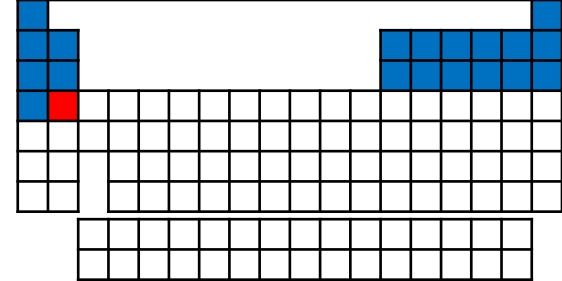

Sc

[Ar]3d4s²

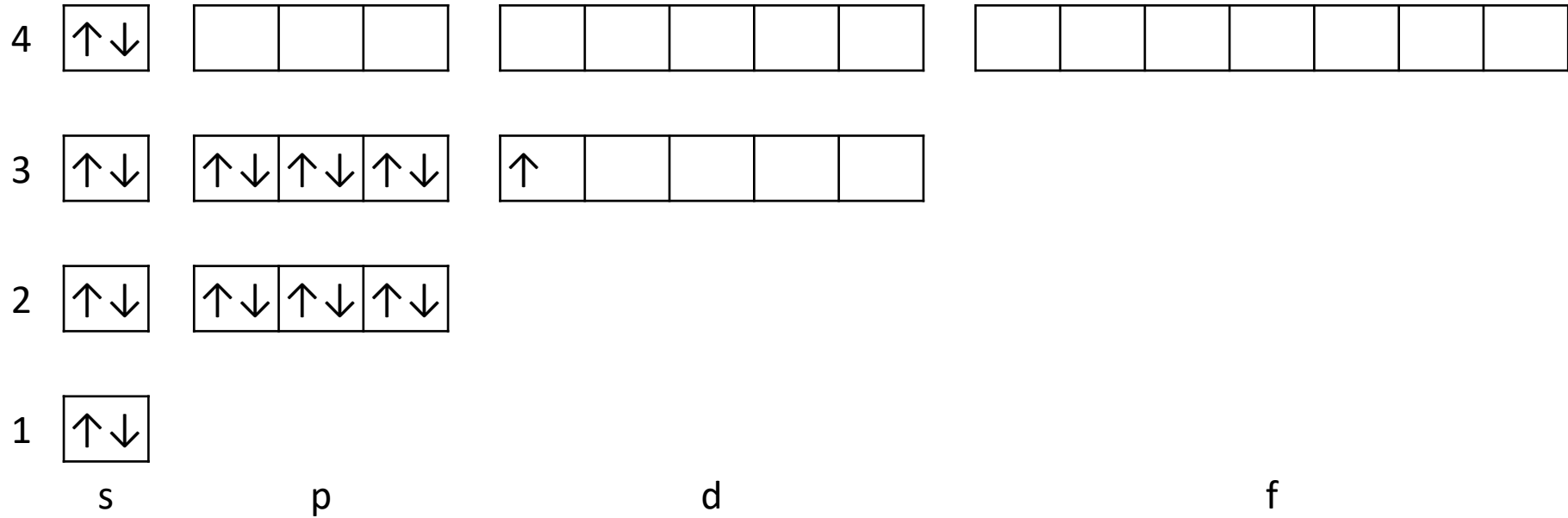
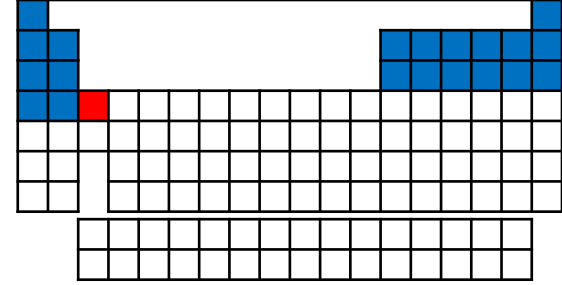

V

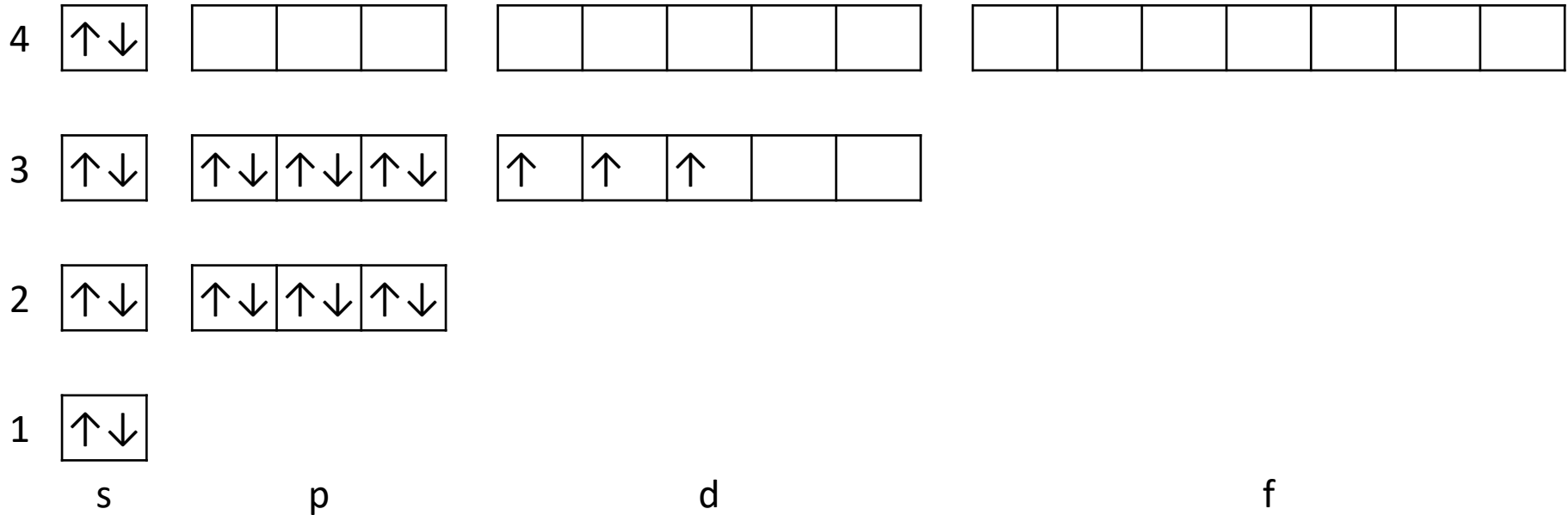
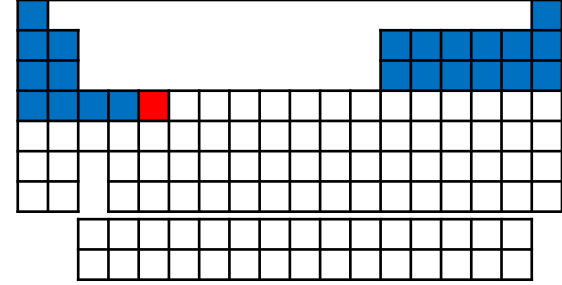

Cr

[Ar]3d⁵4s

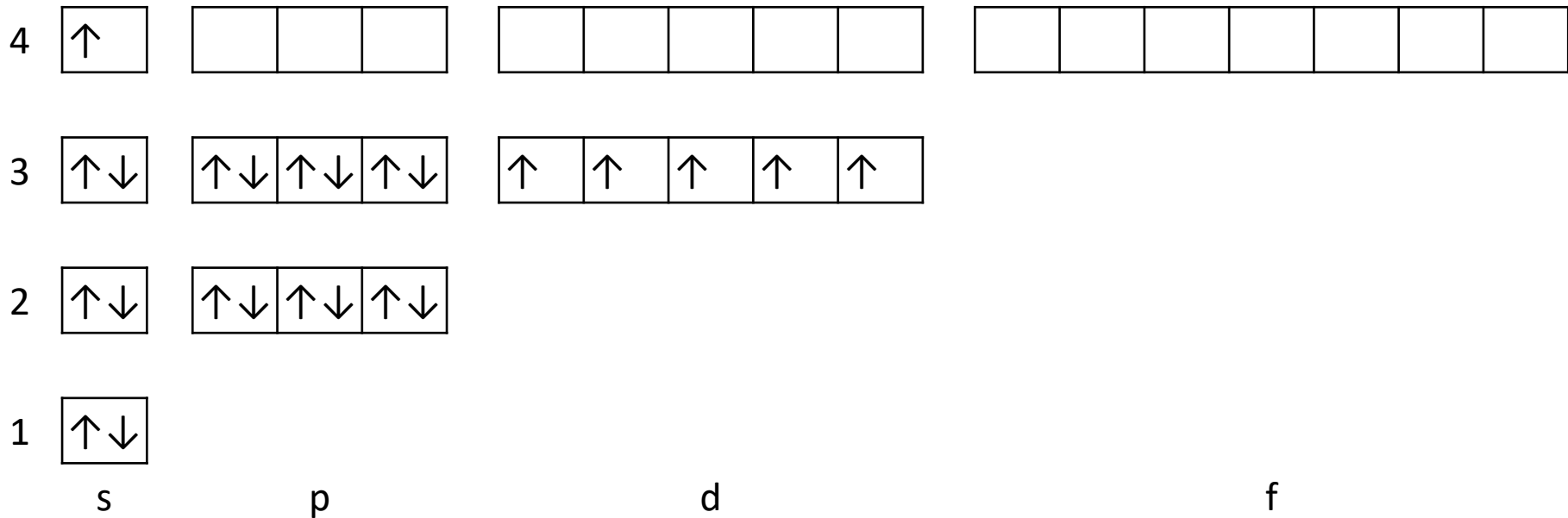
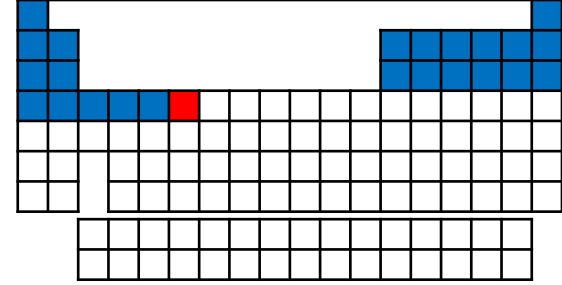

Mn

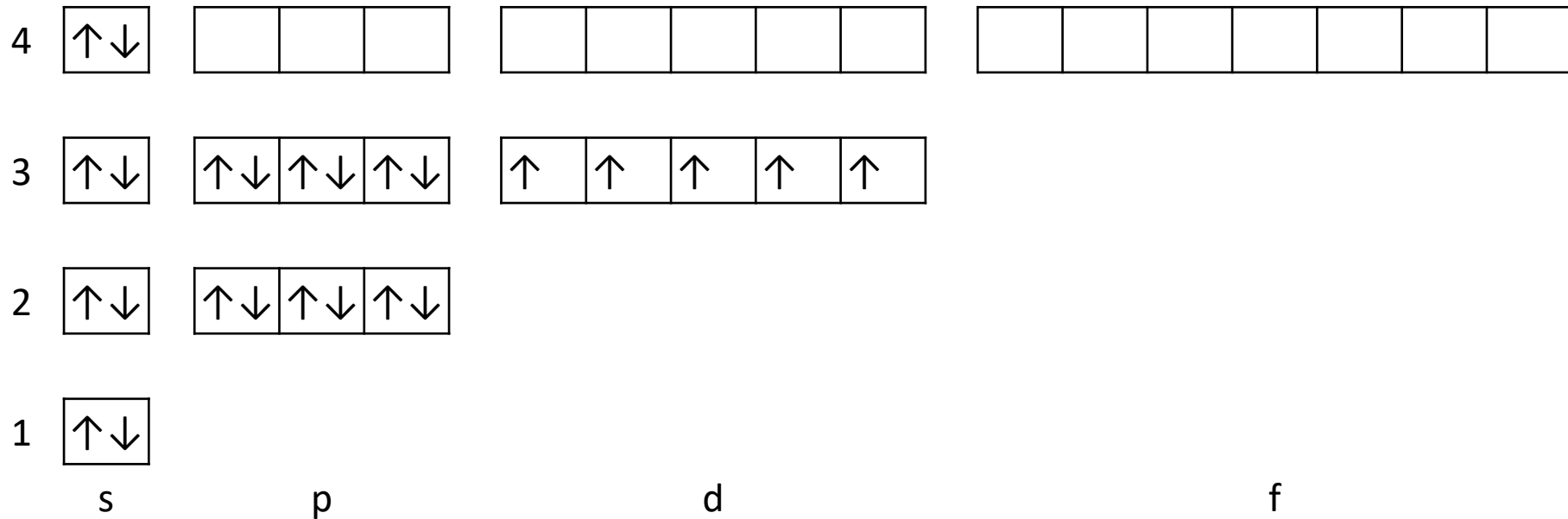
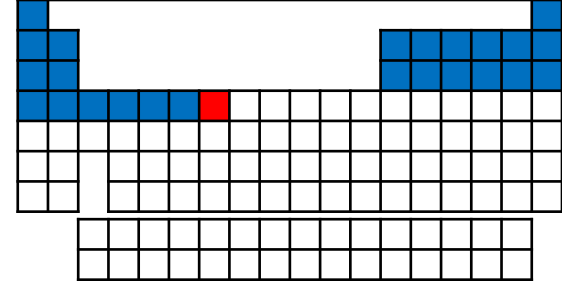

Fe

[Ar]3d⁶4s²

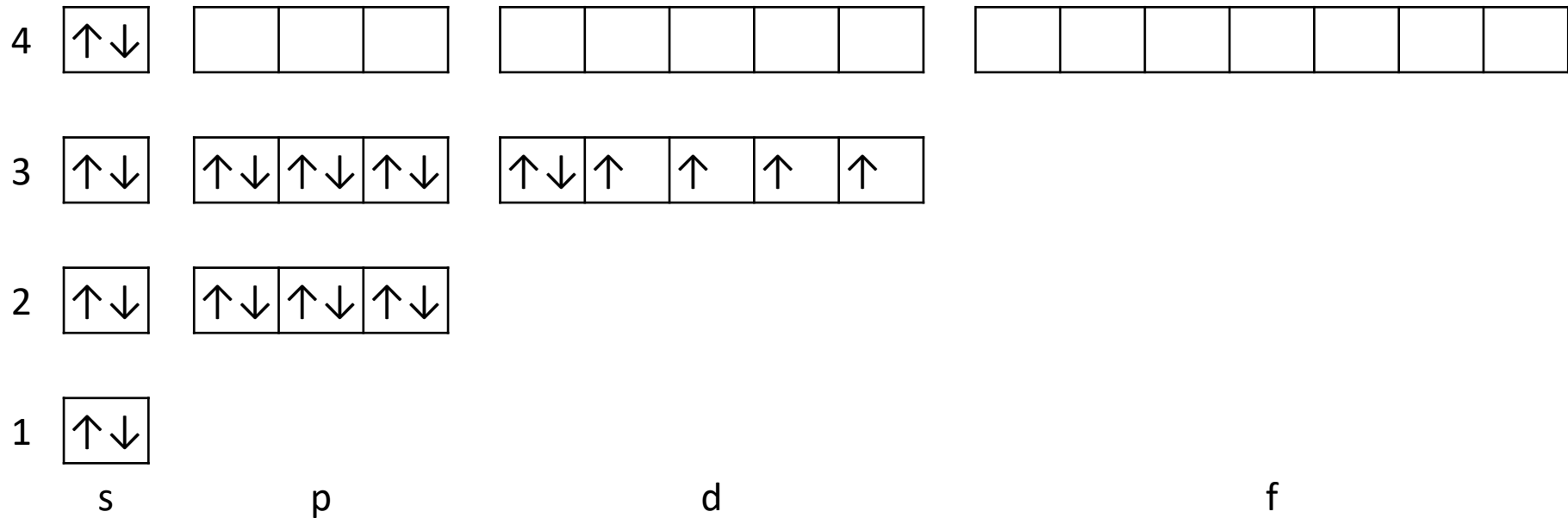
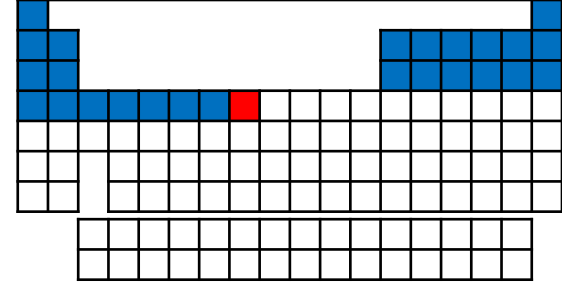

Cu

[Ar]3d¹⁰4s

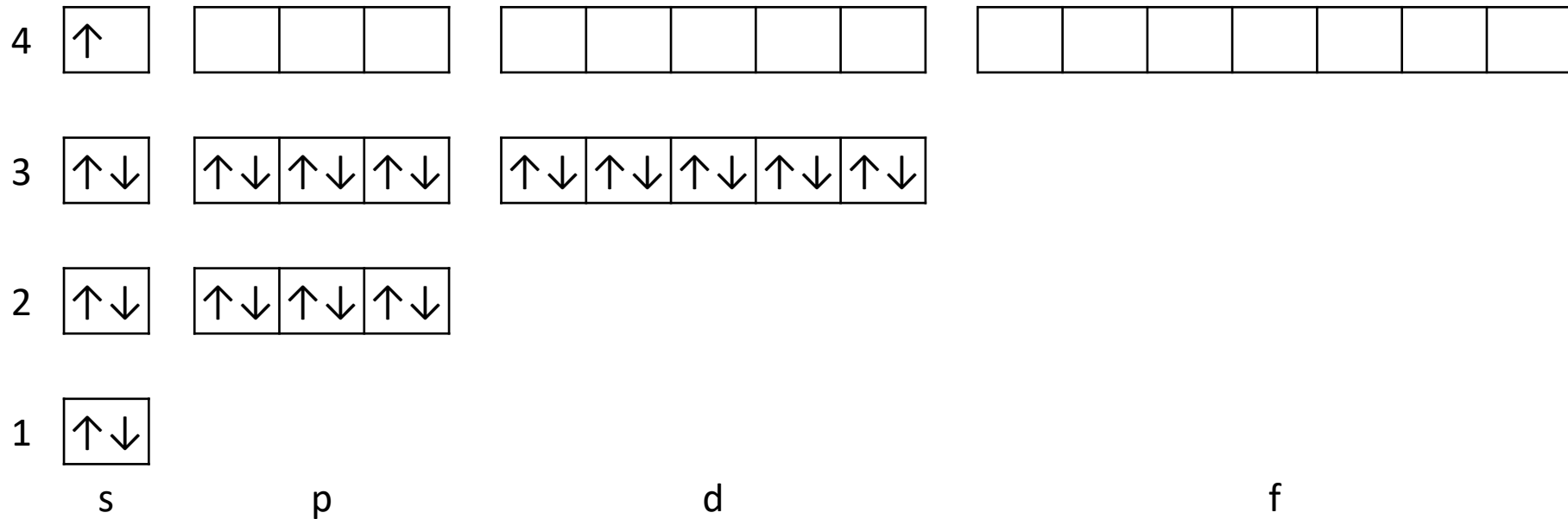
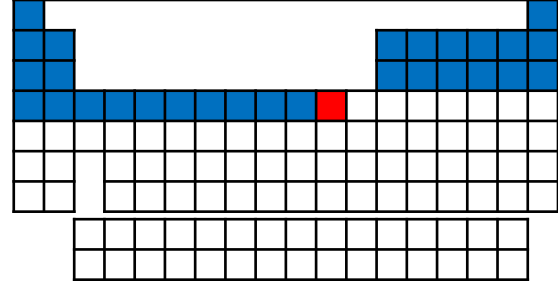

Ge

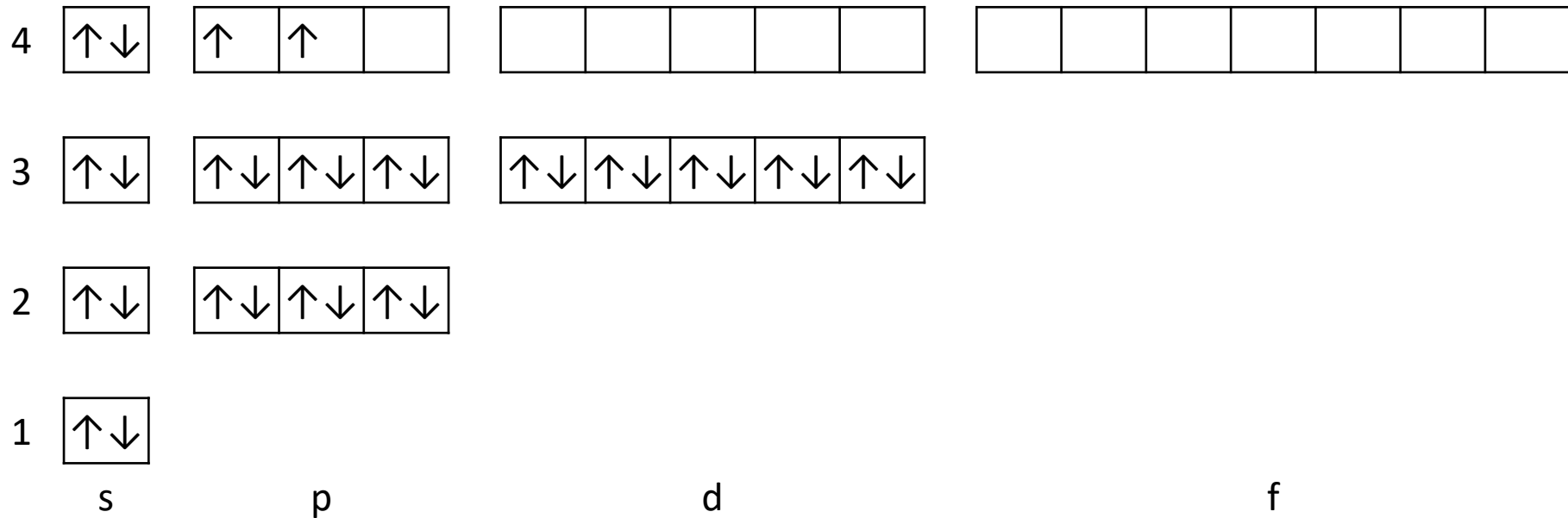
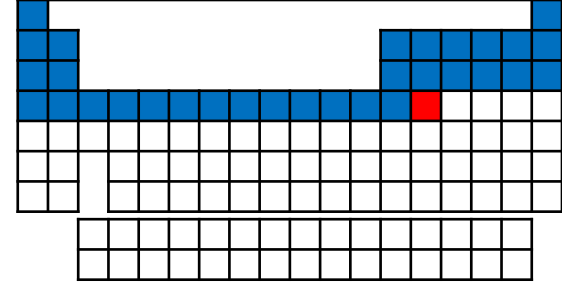
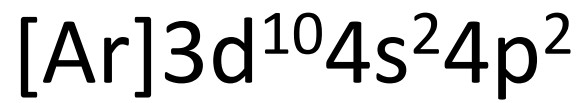

As

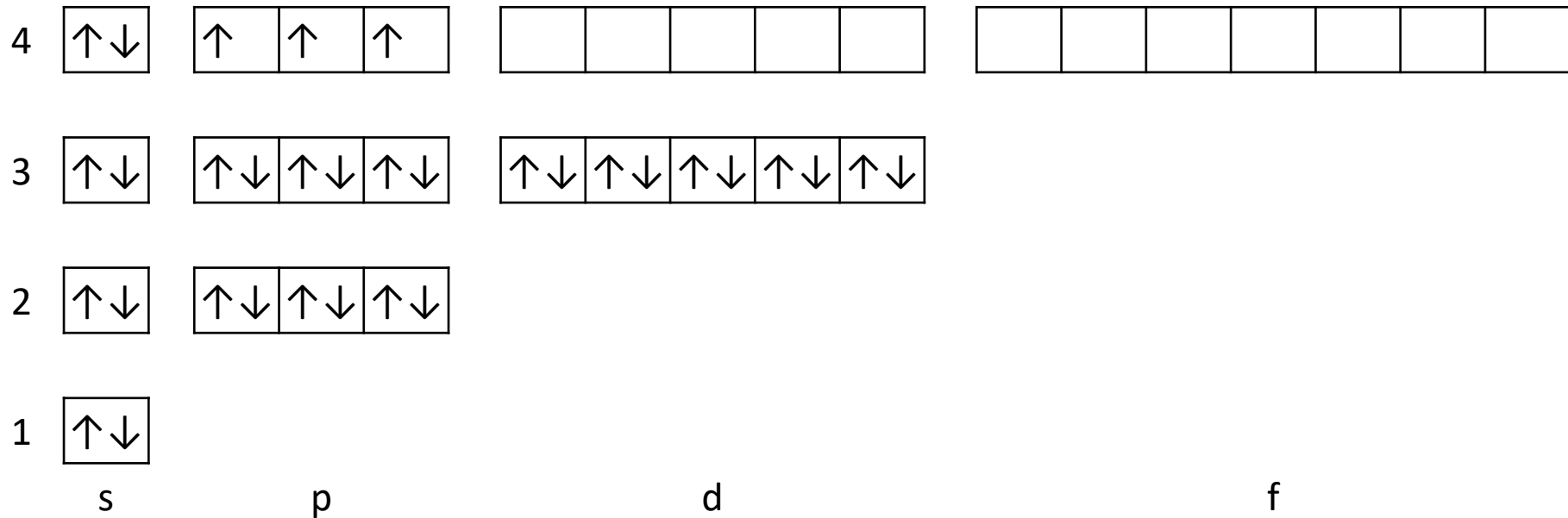
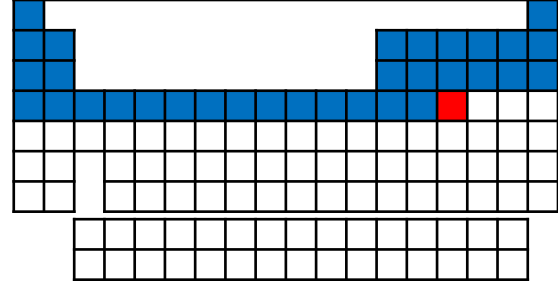
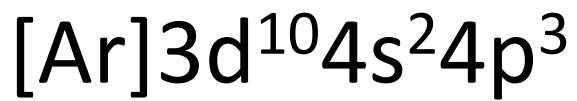

Kr

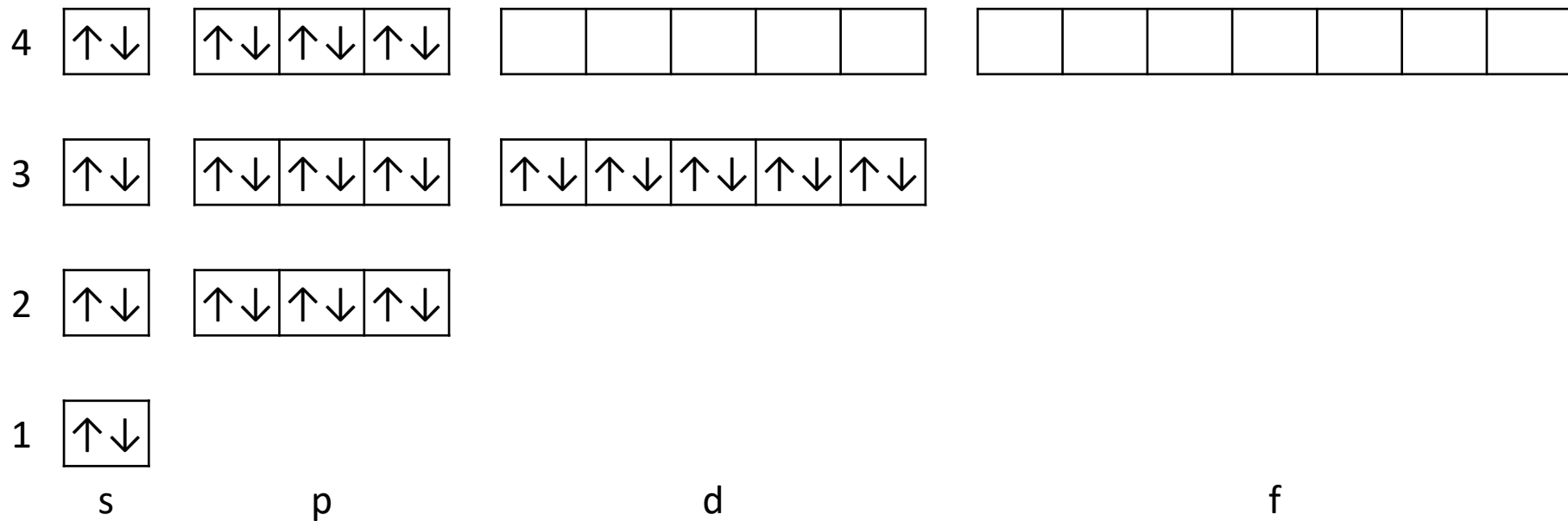
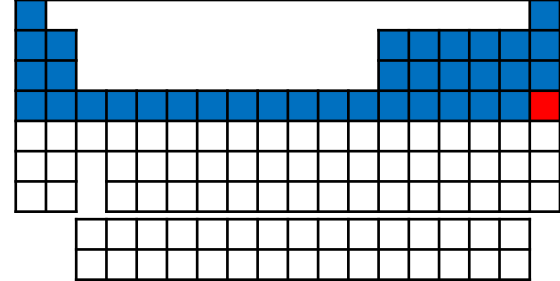
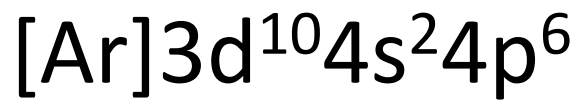

Rb

[Kr]5s

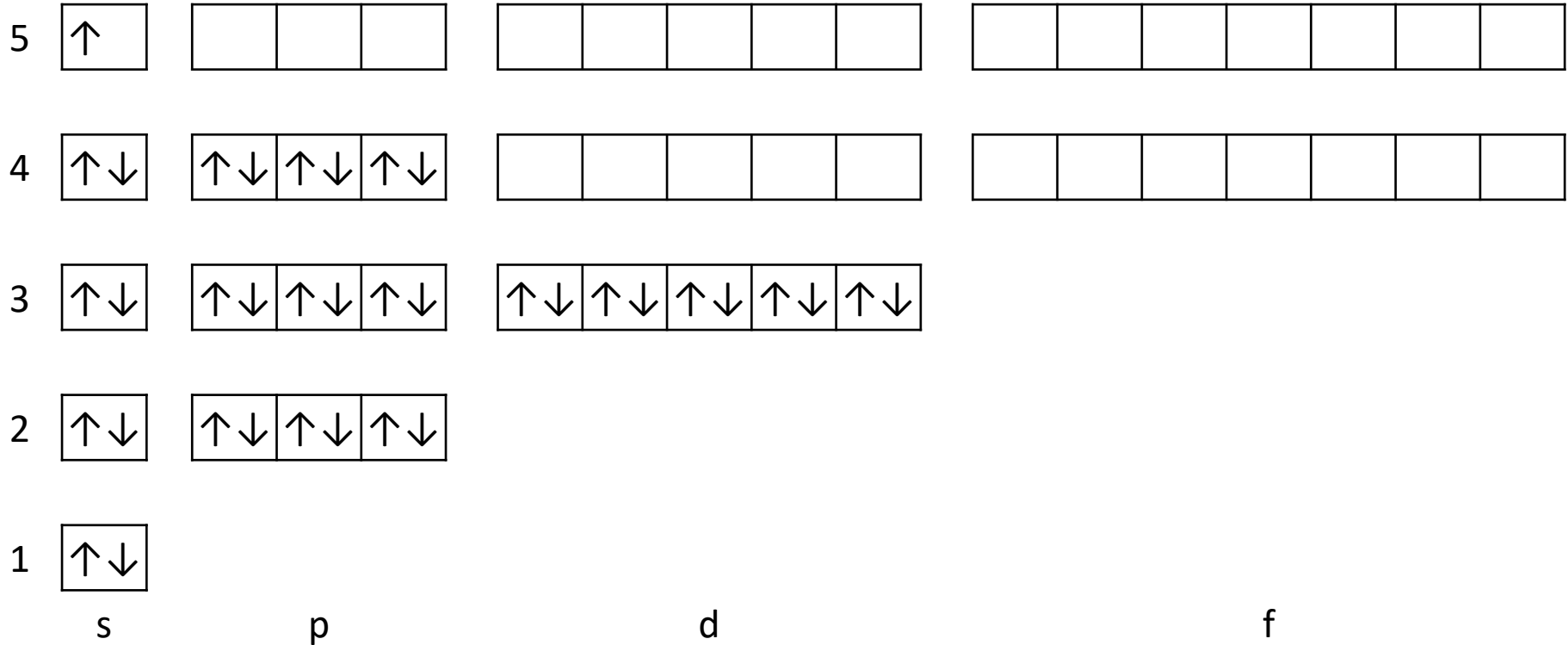
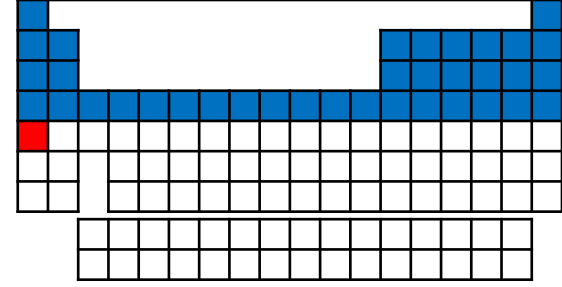

Sr

[Kr]5s²

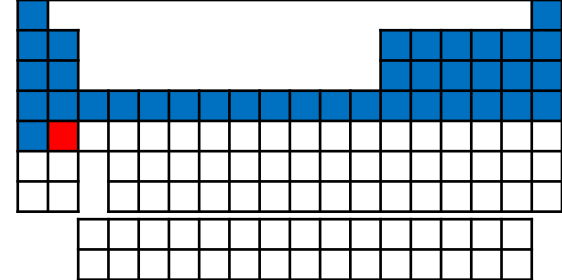

5

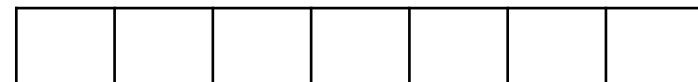
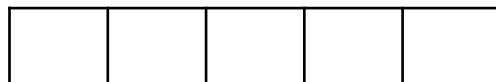
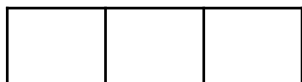
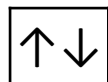

4

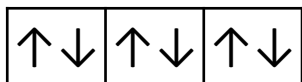
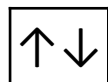

3

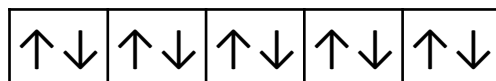
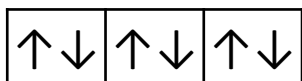
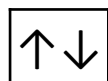

2

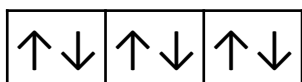
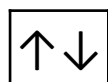

1

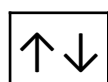

s

p

d

f

Y

[Kr]4d5s²

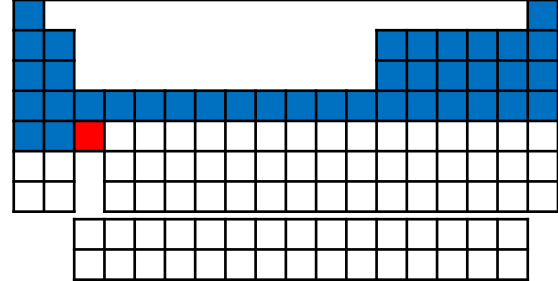

5

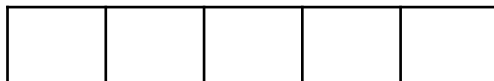
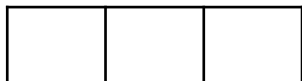
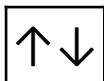

4

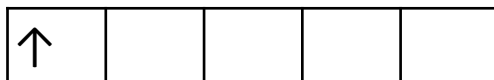
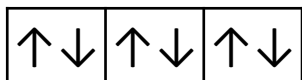
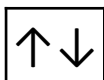

3

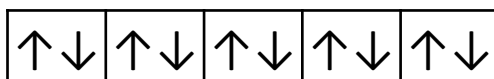
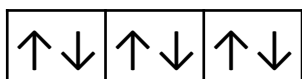
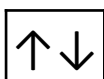

2

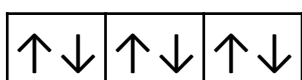

1



s

p

d

f

Zr

[Kr]4d²5s²

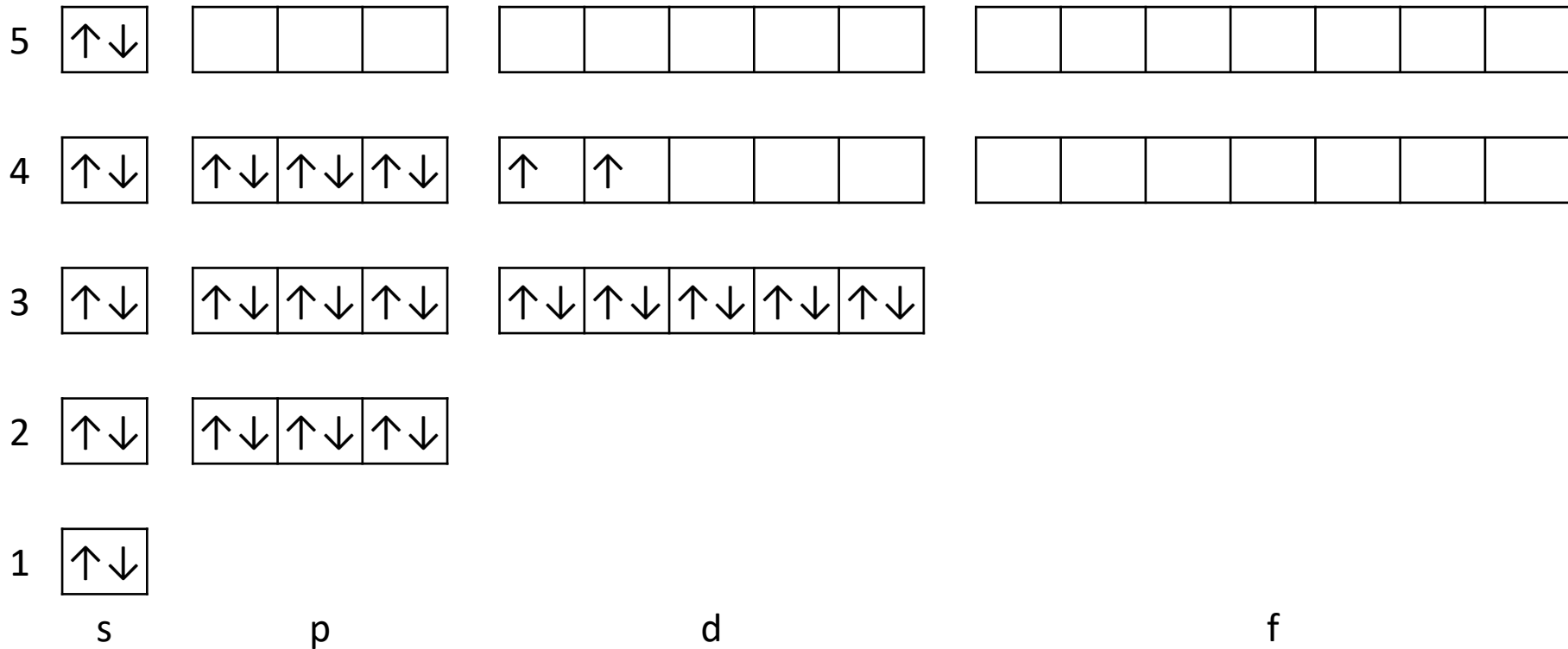
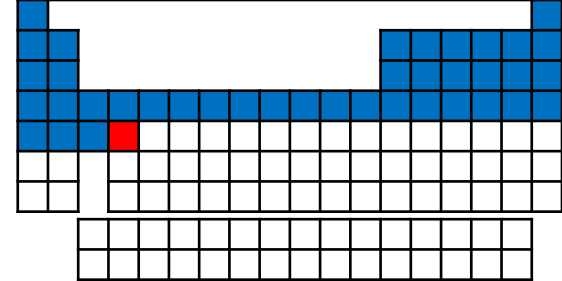

Nb

[Kr]4d⁴5s

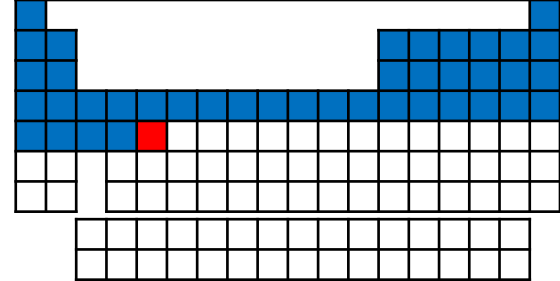

5

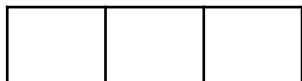
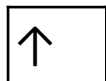

4

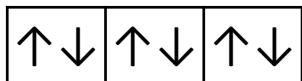
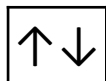

3

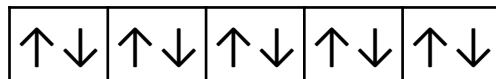
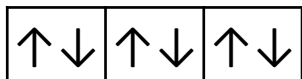
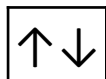

2

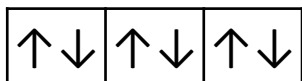
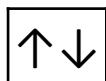

1

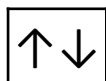

s

p

d

f

Mo

[Kr]4d⁵5s

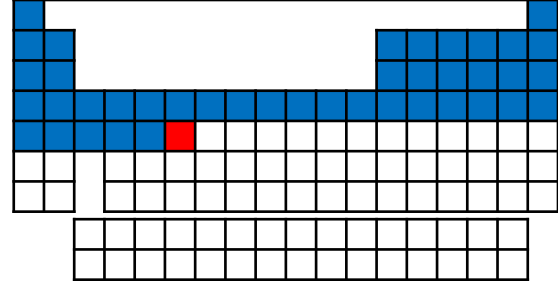

5

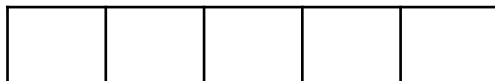
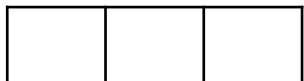
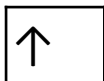

4

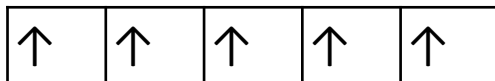
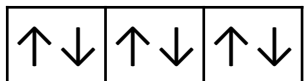
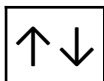

3

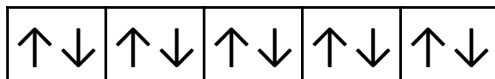
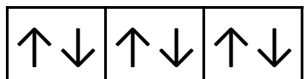
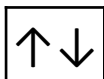

2

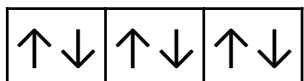
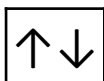

1

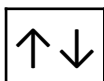

s

p

d

f

Tc

[Kr]4d⁶5s

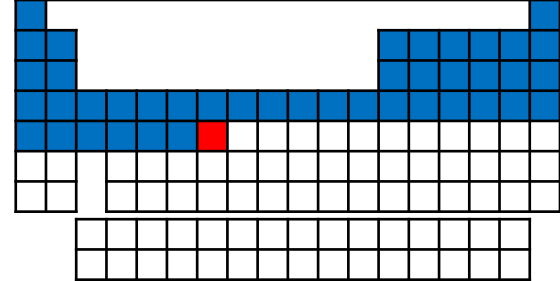

5

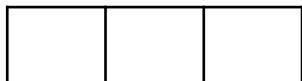
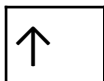

4

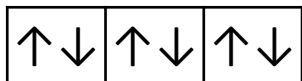

3

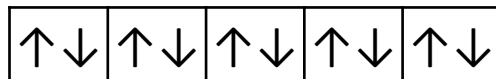
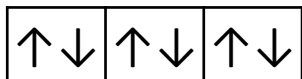
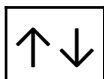

2

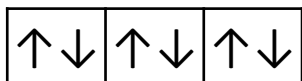
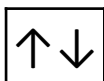

1

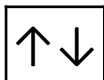

s

p

d

f

Ru

[Kr]4d⁷5s

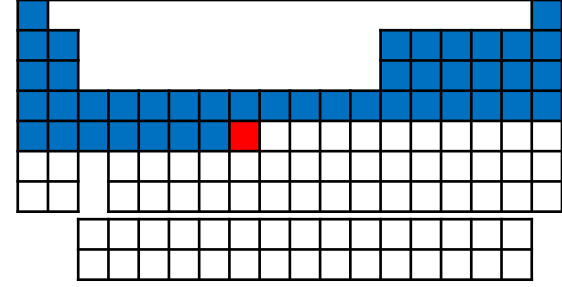

5

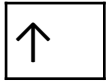

4

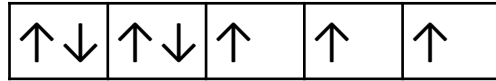
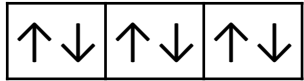
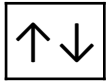

3



2



1



s

p

d

f

Rh

[Kr]4d⁸5s

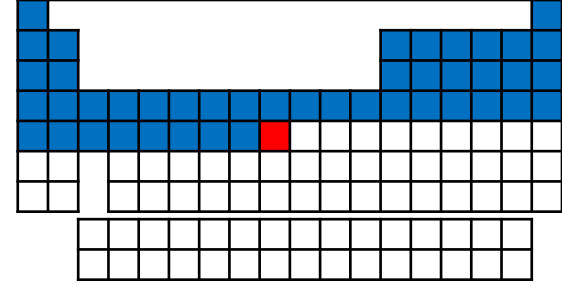

5

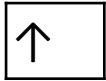

4

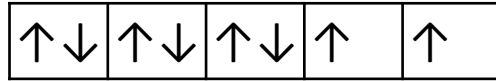
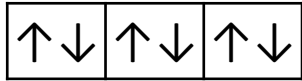
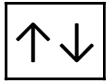

3

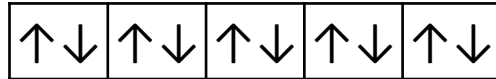
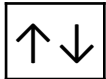

2



1



s

p

d

f

Pd

[Kr]4d¹⁰

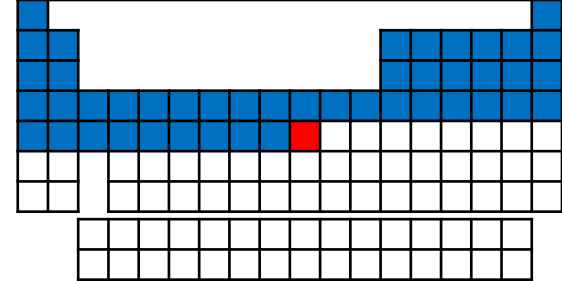

5

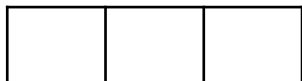
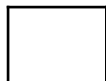

4

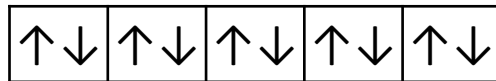
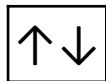

3

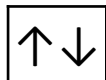

2

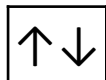

1

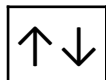

s

p

d

f

Ag

[Kr]4d¹⁰5s

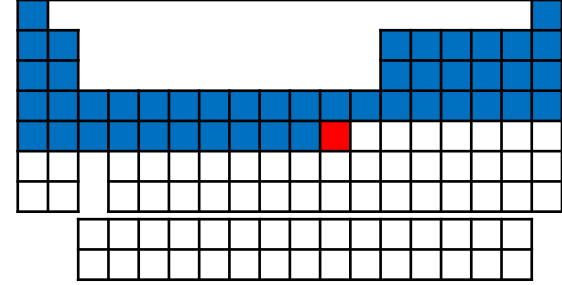

5

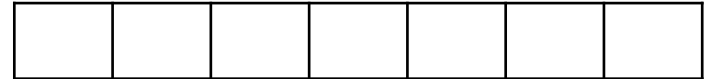
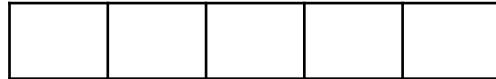
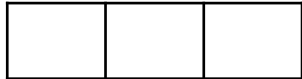
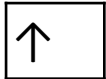

4

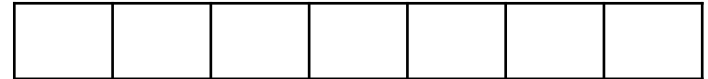
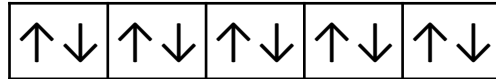
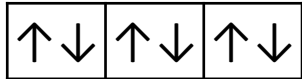

3



2



1

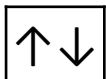

s

p

d

f

In

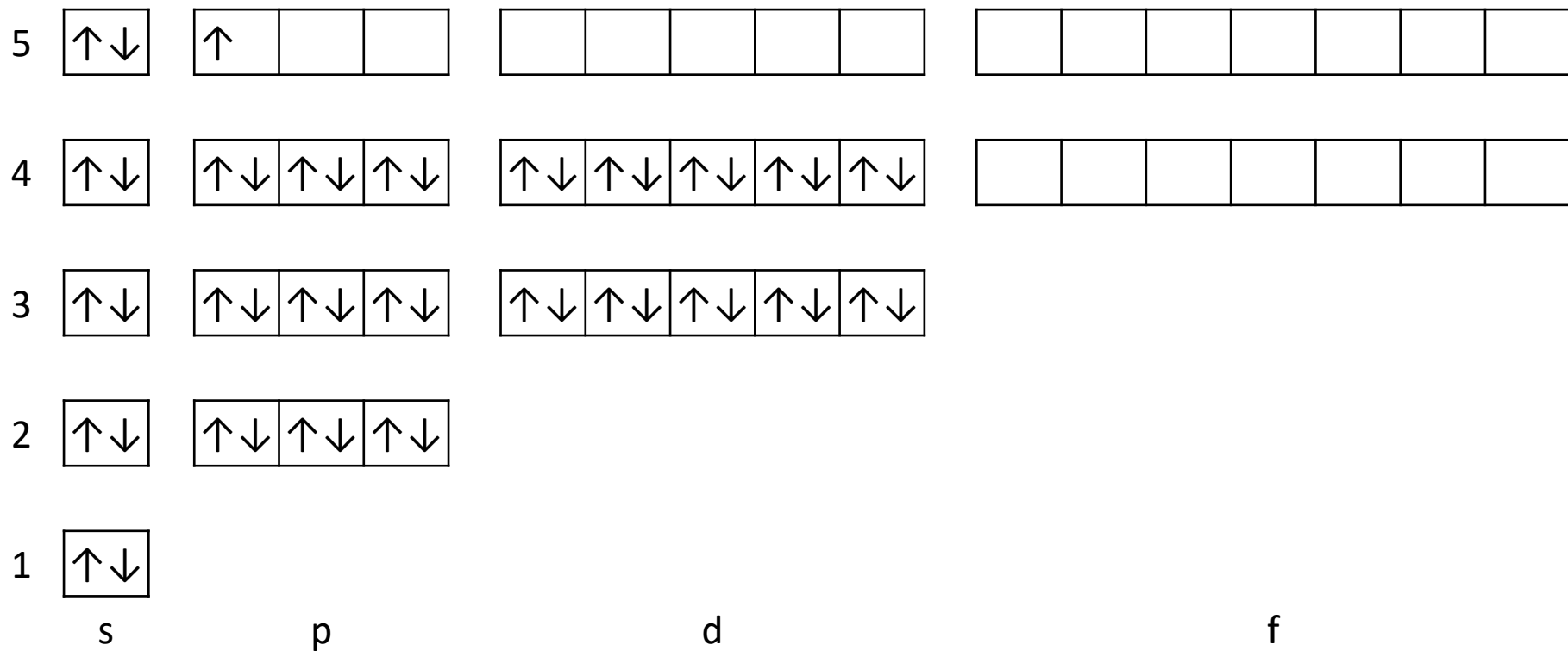
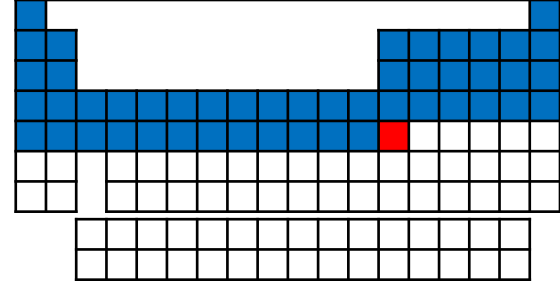
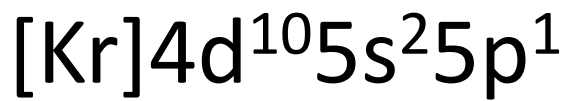

Sn

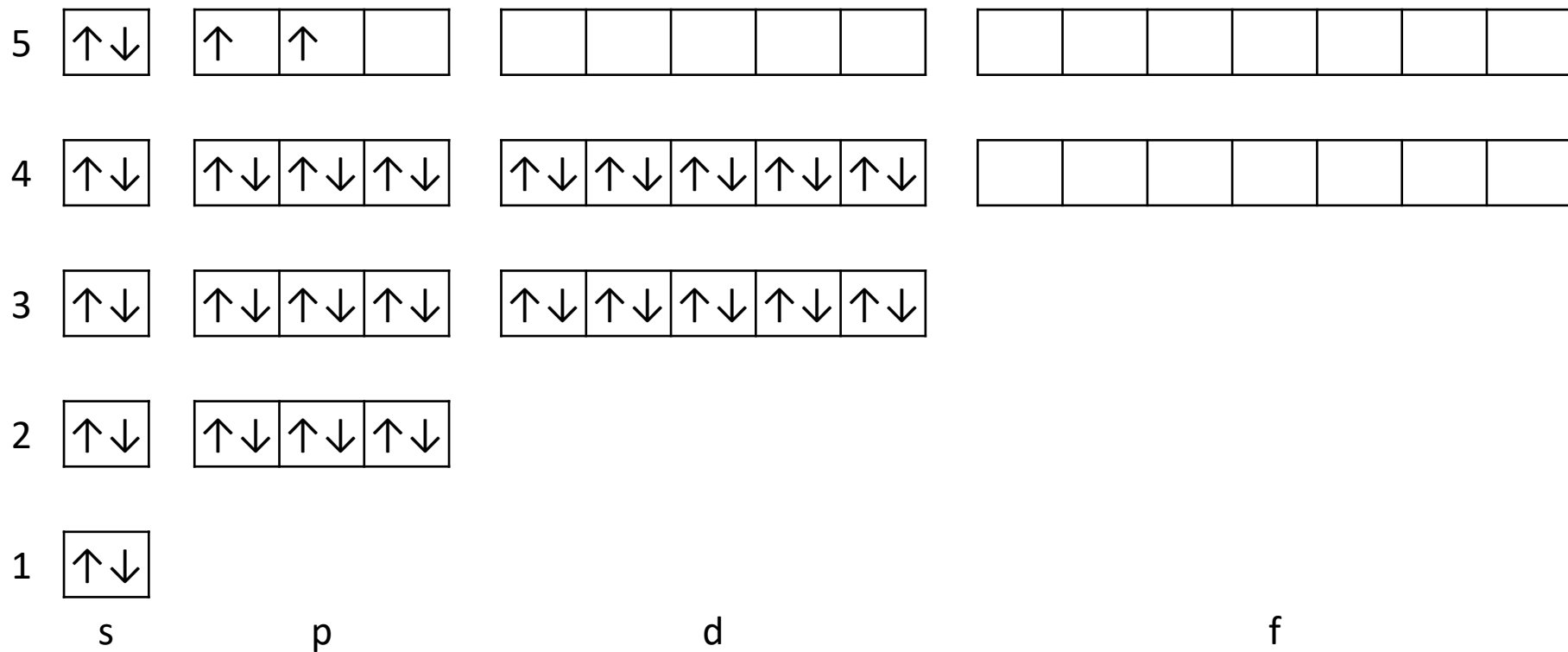
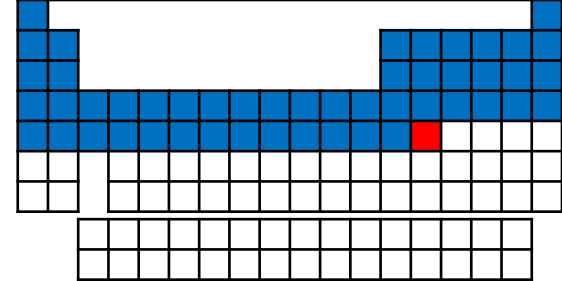
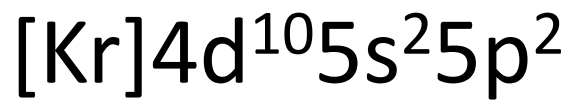

Sb

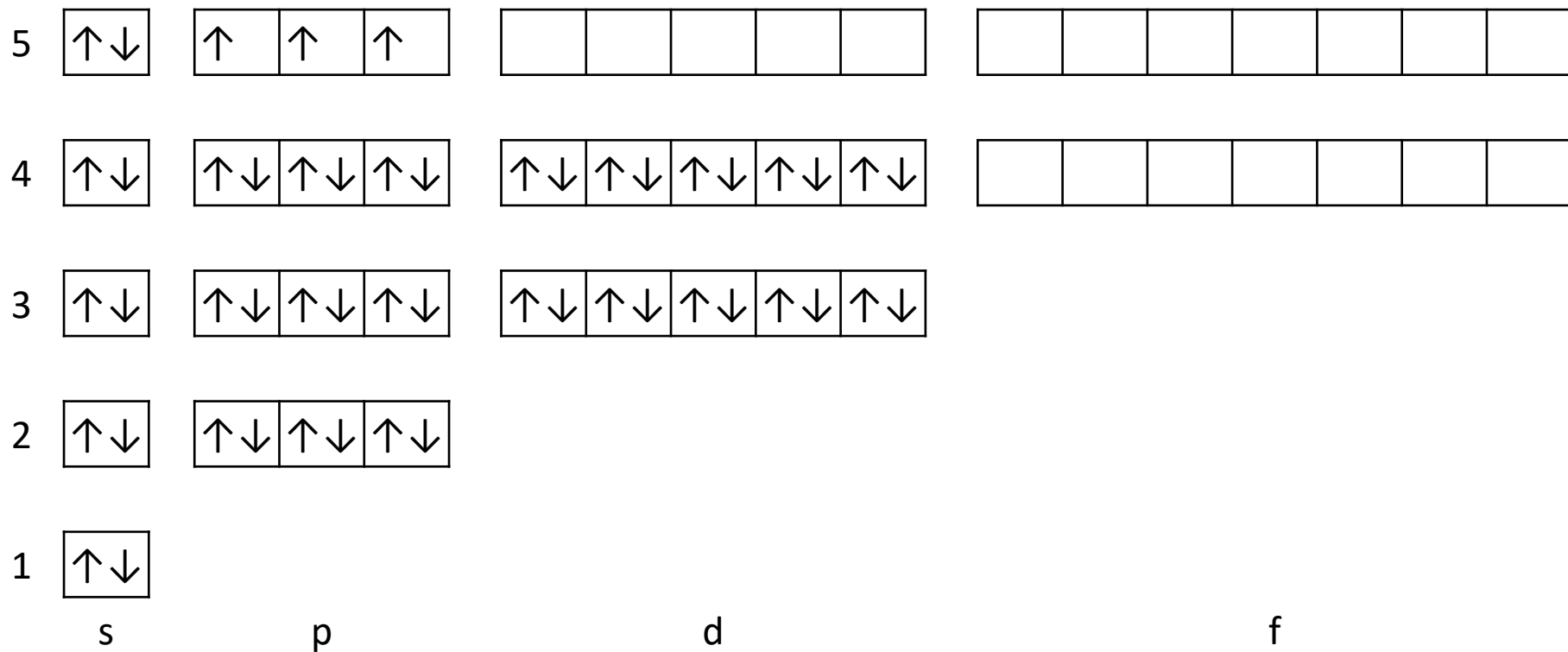
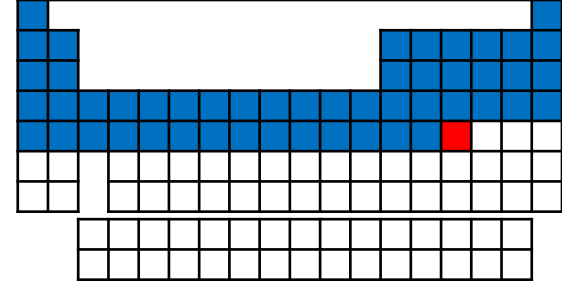
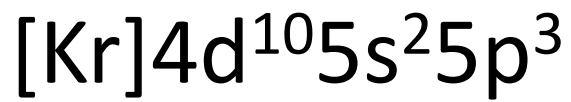

I

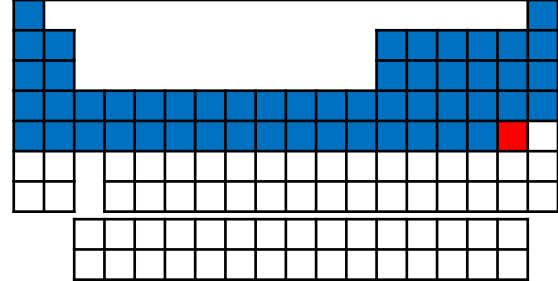
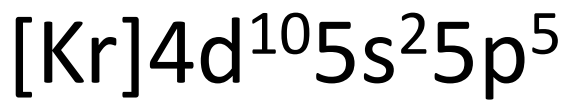

5

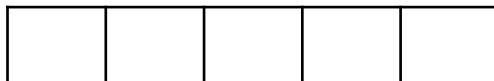
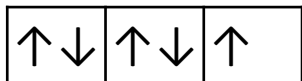
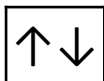

4

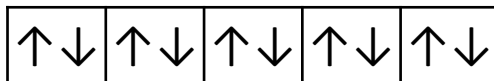
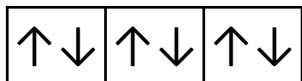
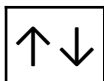

3

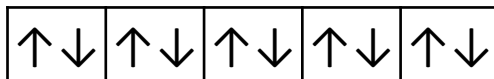
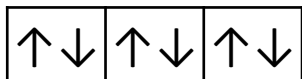
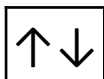

2

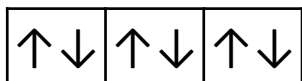

1

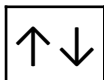

s

p

d

f

Xe

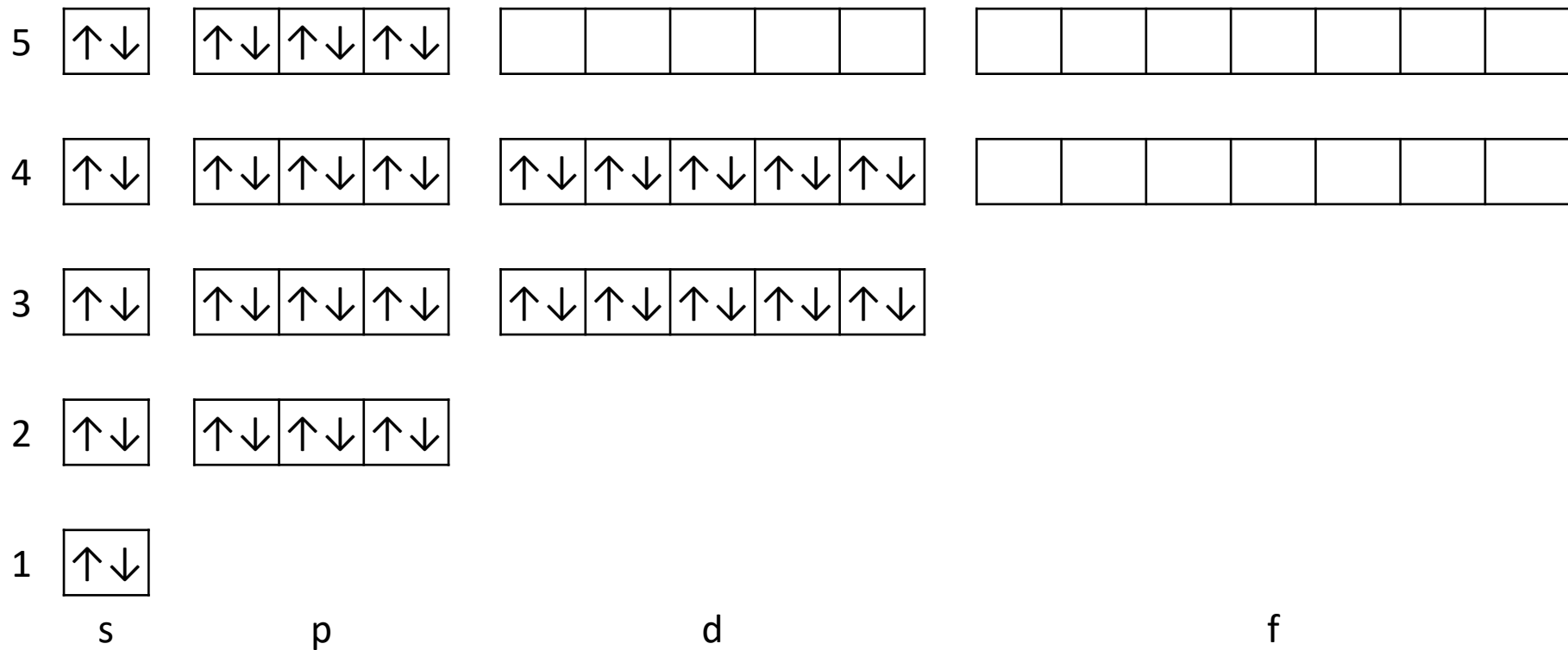
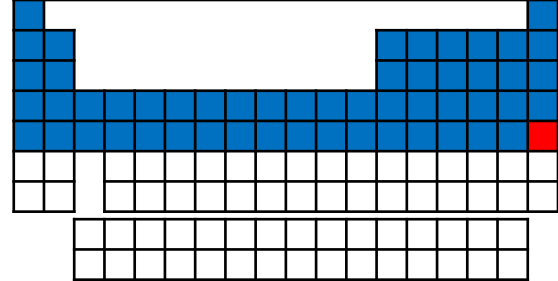
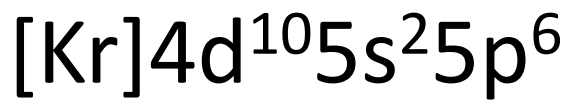

Ba

[Xe]6s²

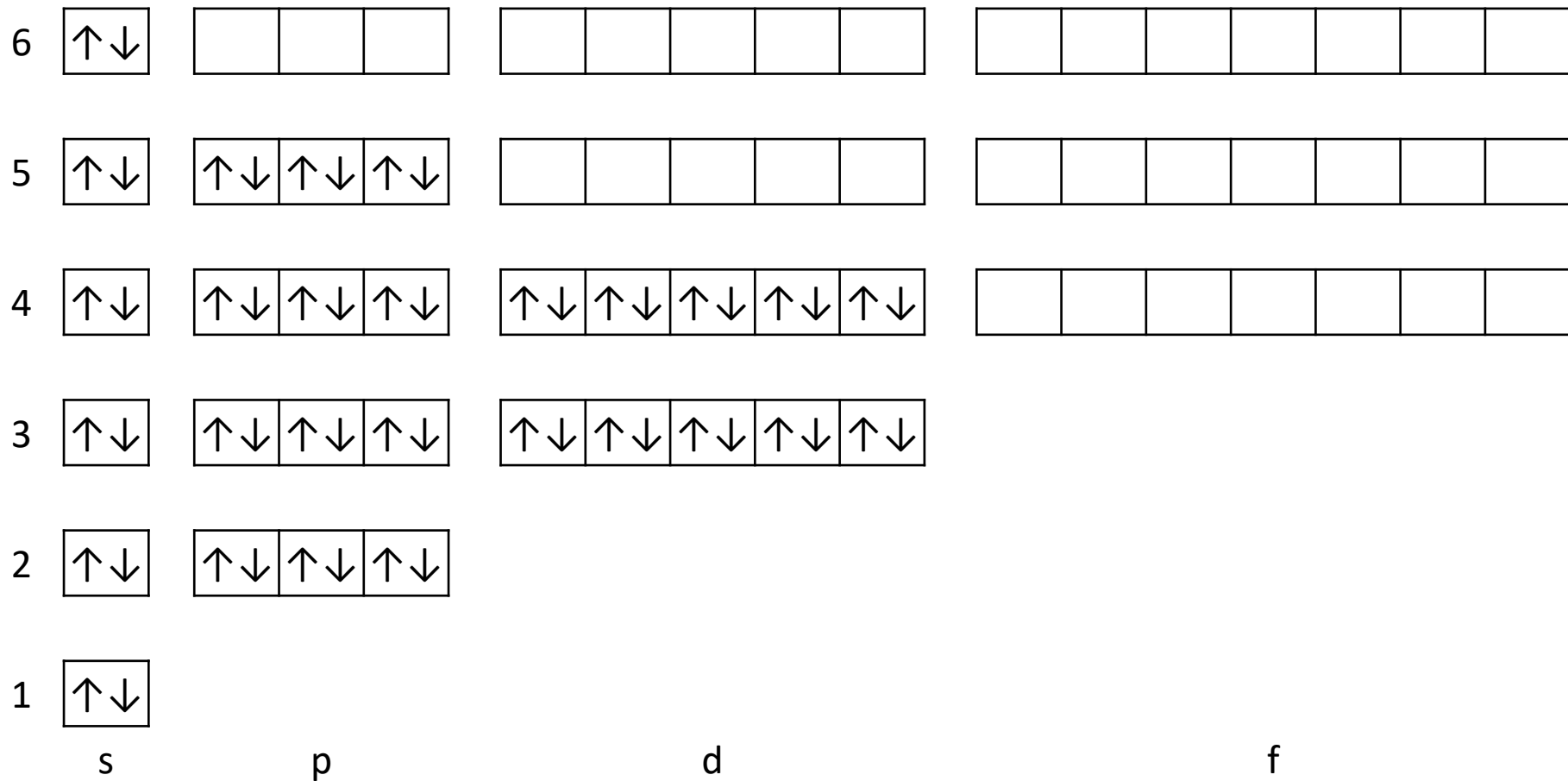
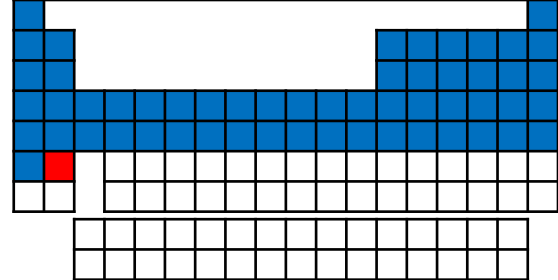

La

[Xe]5d6s²

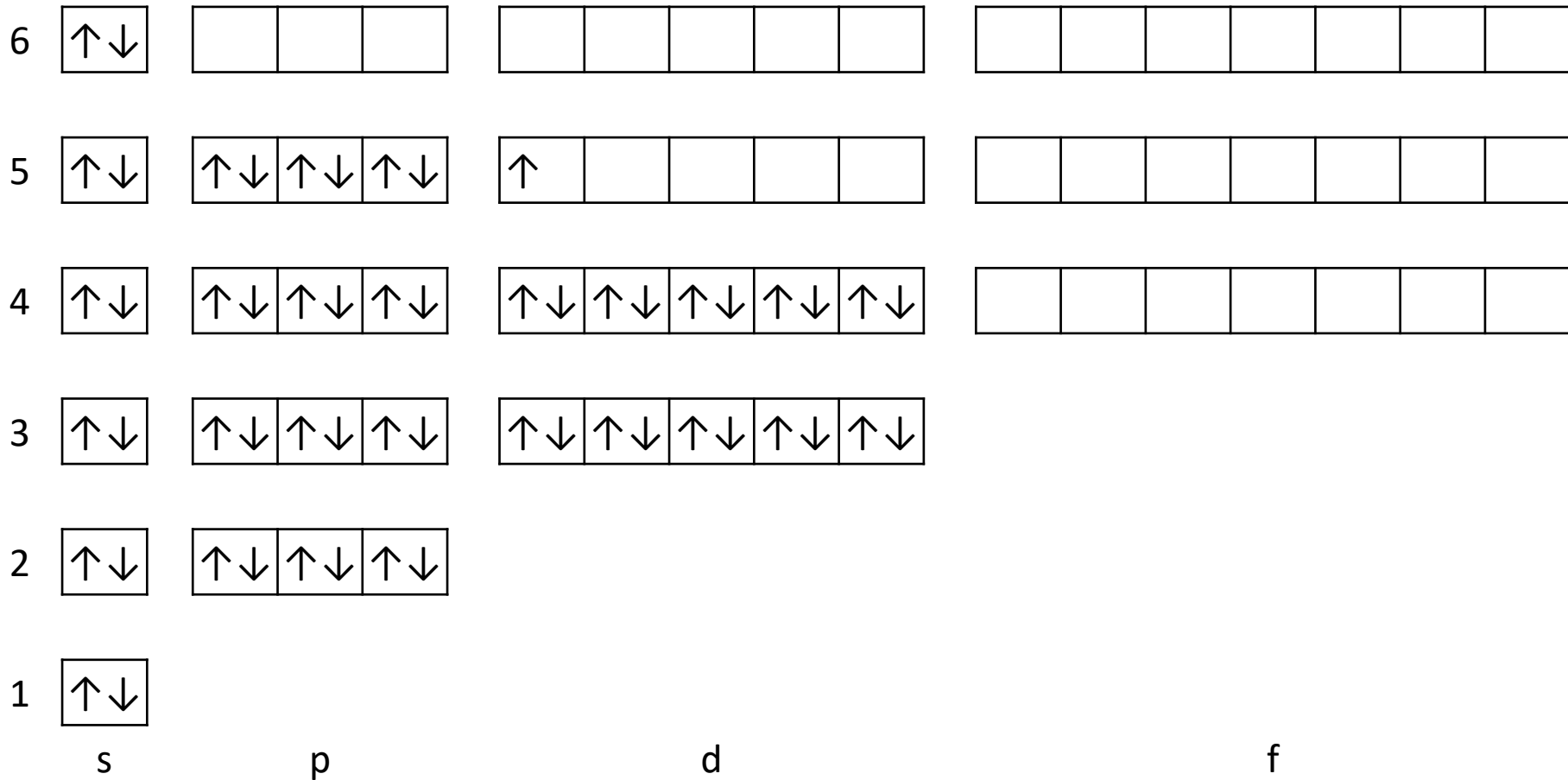
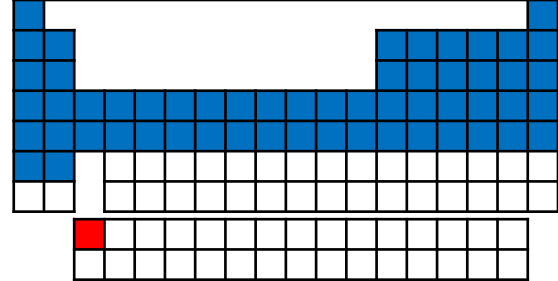

Ce

[Xe]4f5d6s²

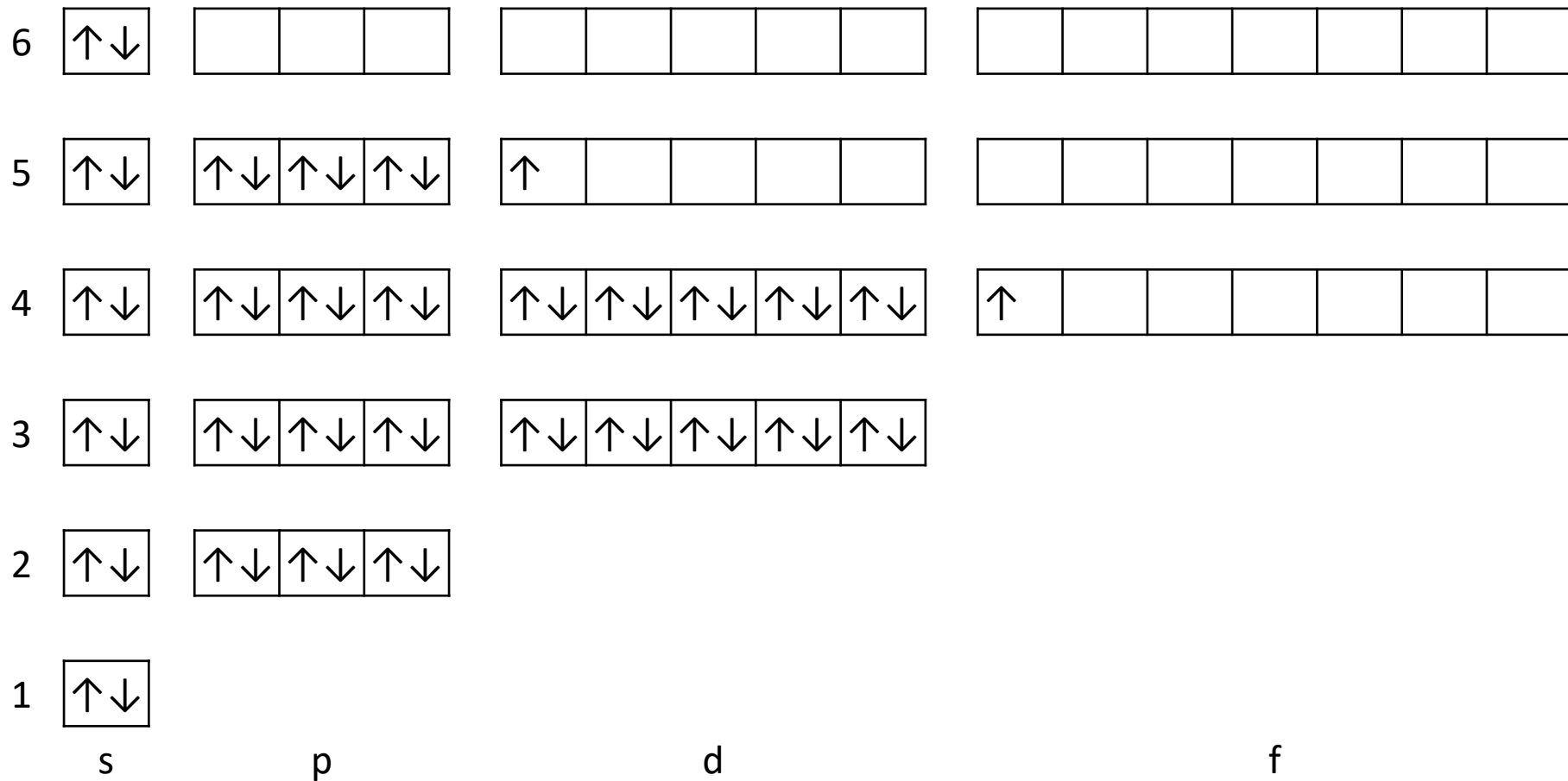
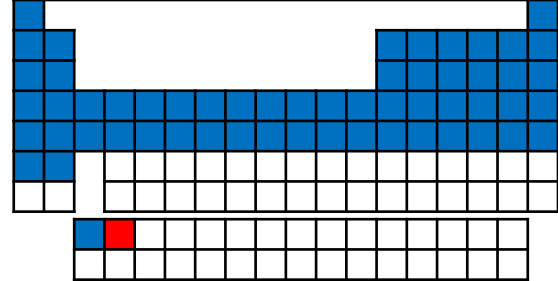

Pm

[Xe]4f⁵6s²

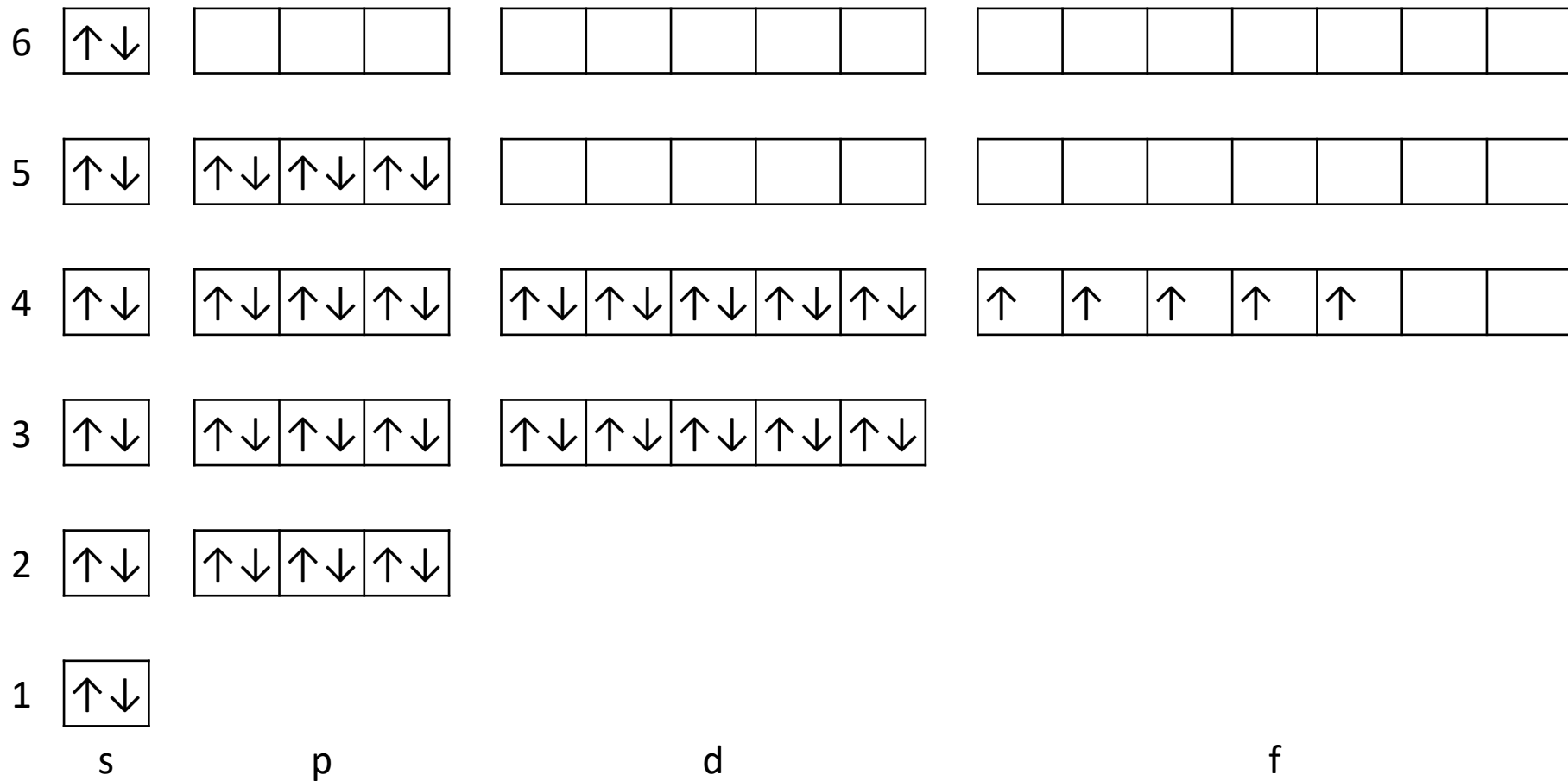
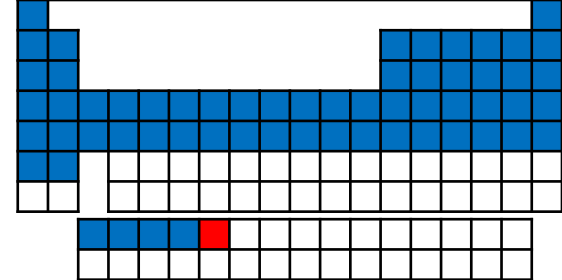

Sm

[Xe]4f⁶6s²

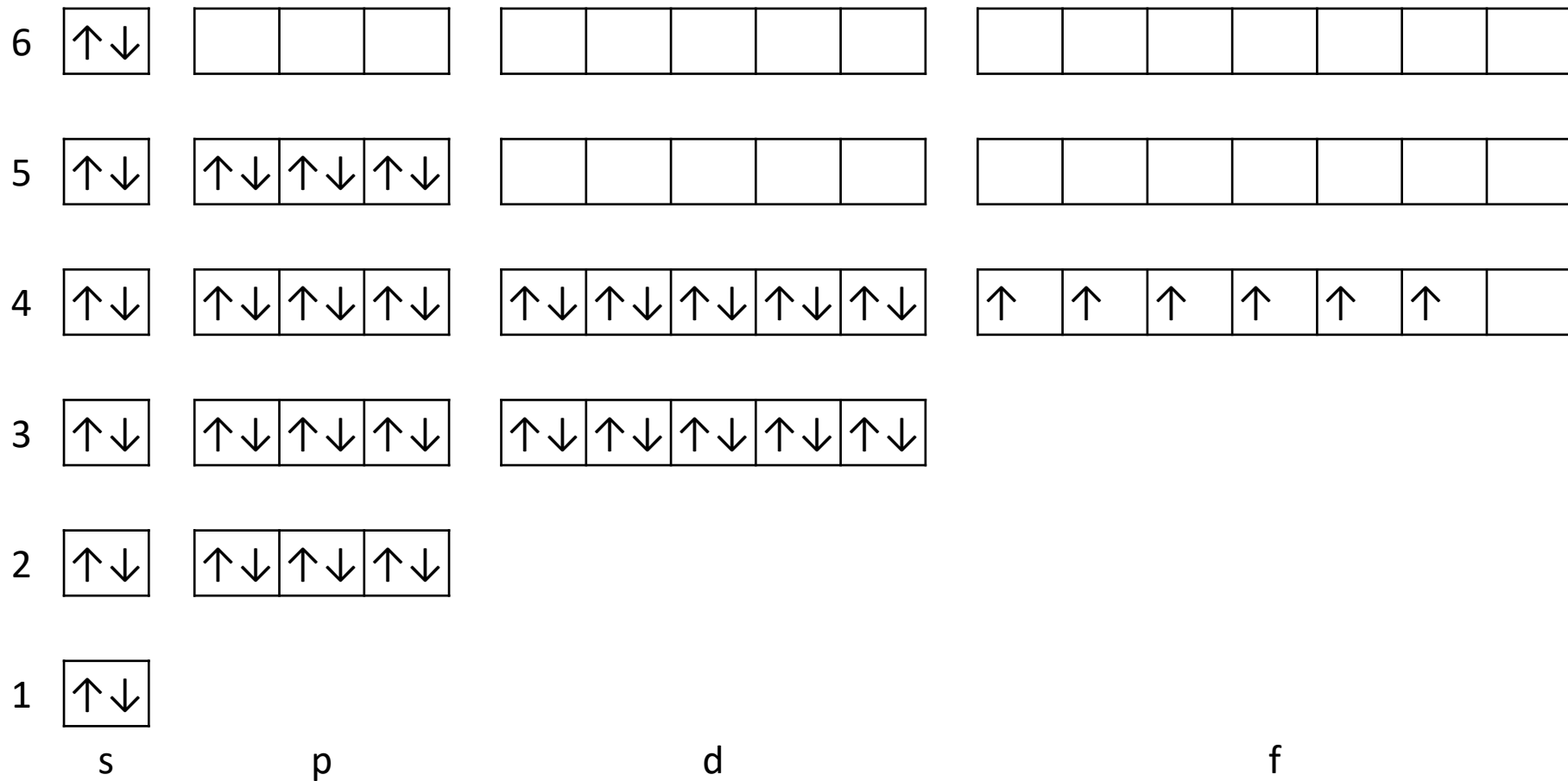
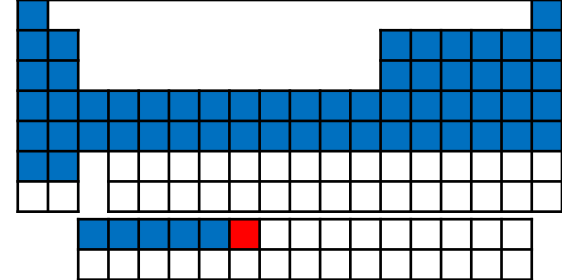

Eu

[Xe]4f⁷6s²

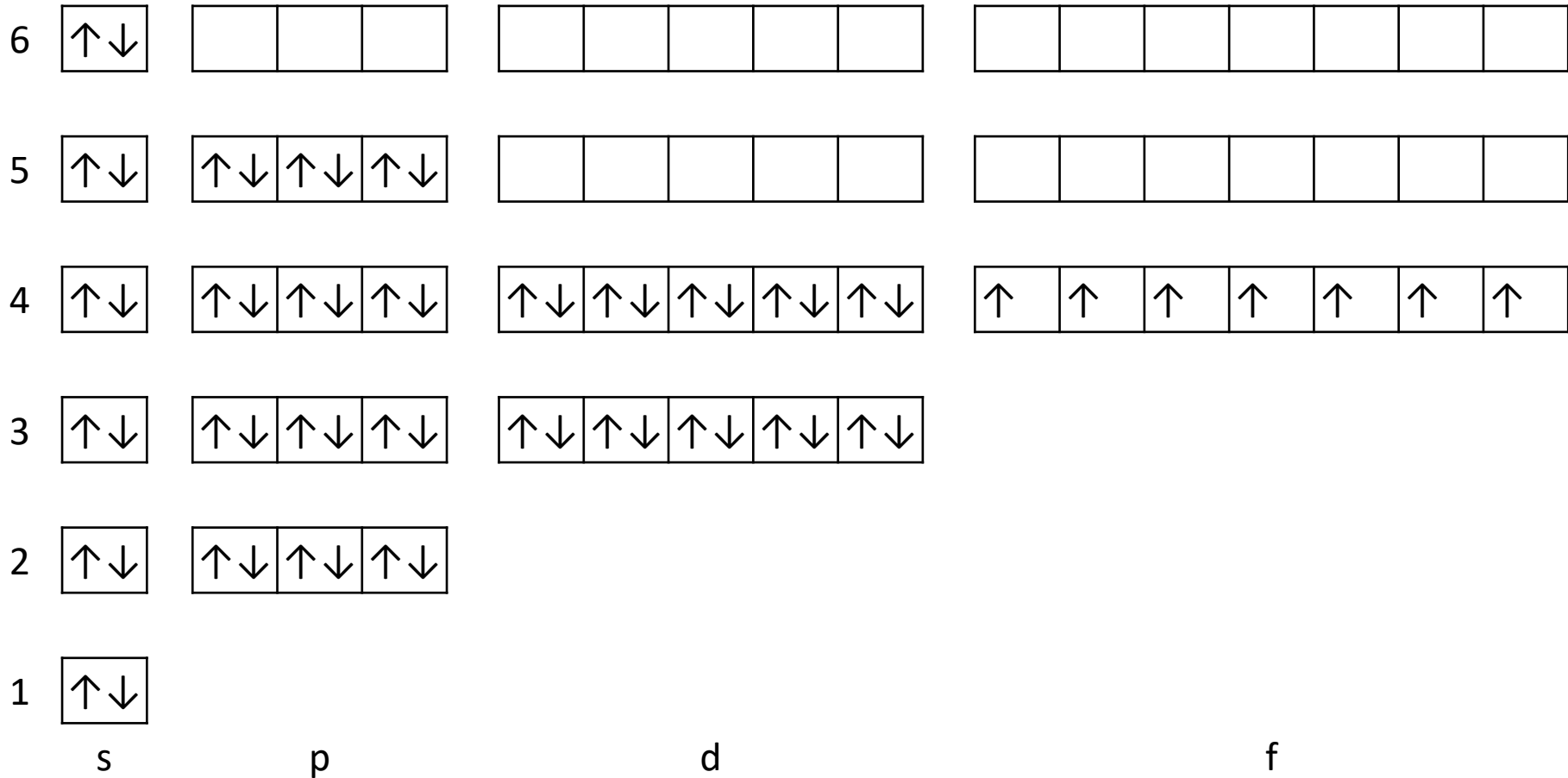
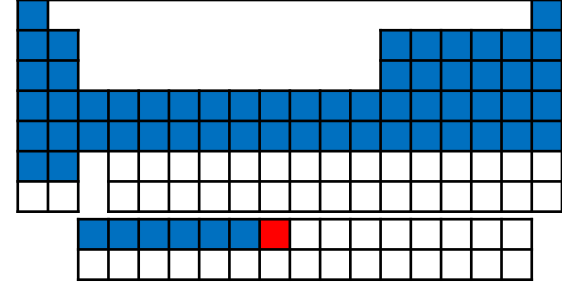

Gd

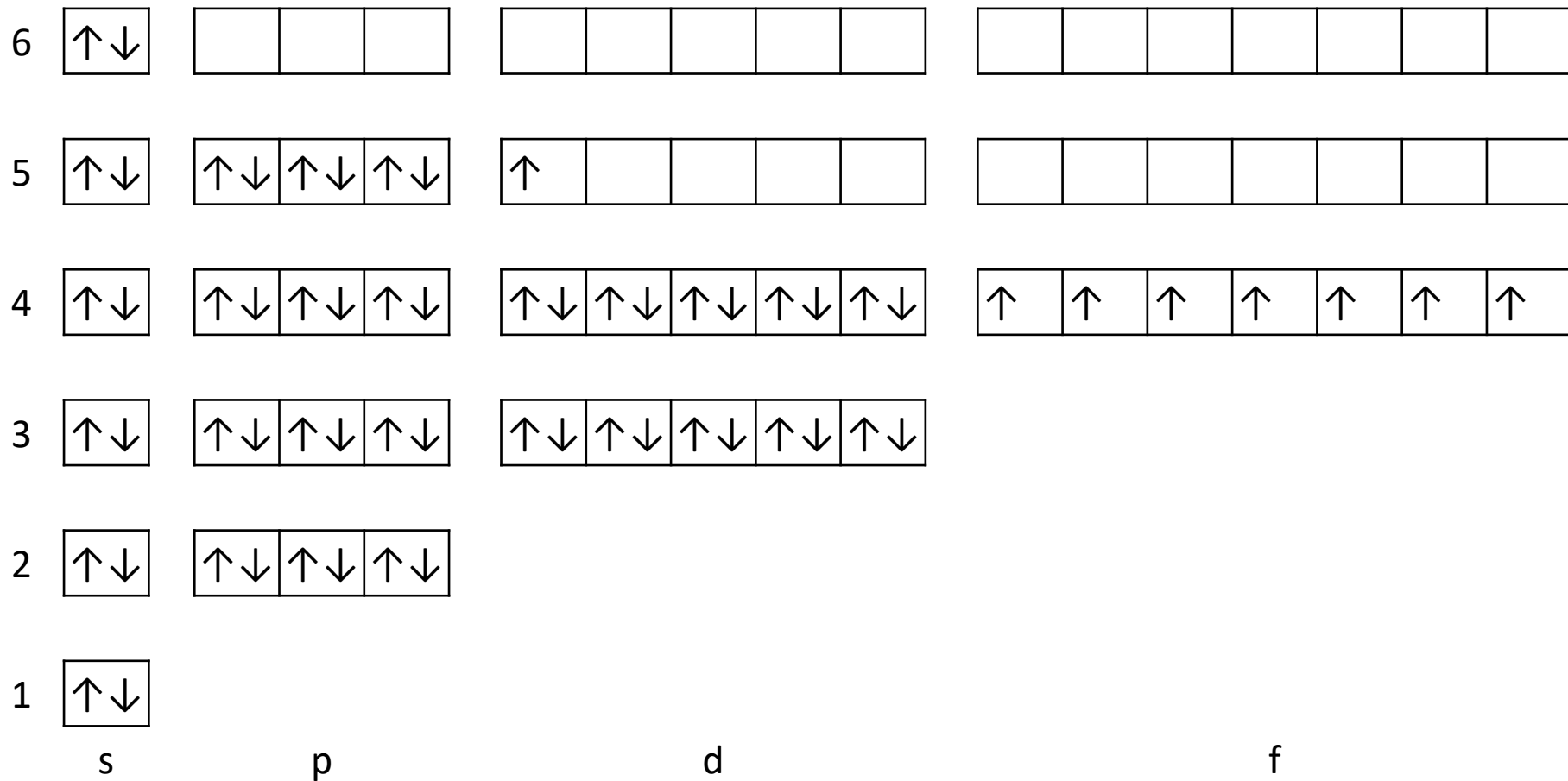
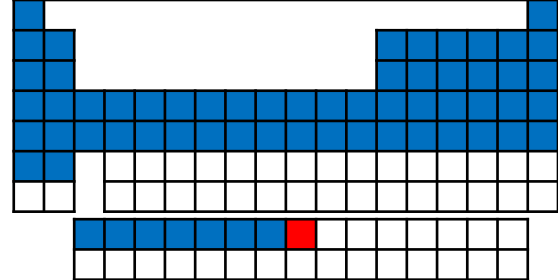
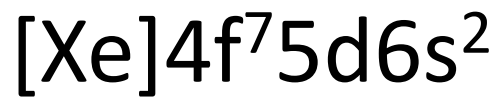

Tb

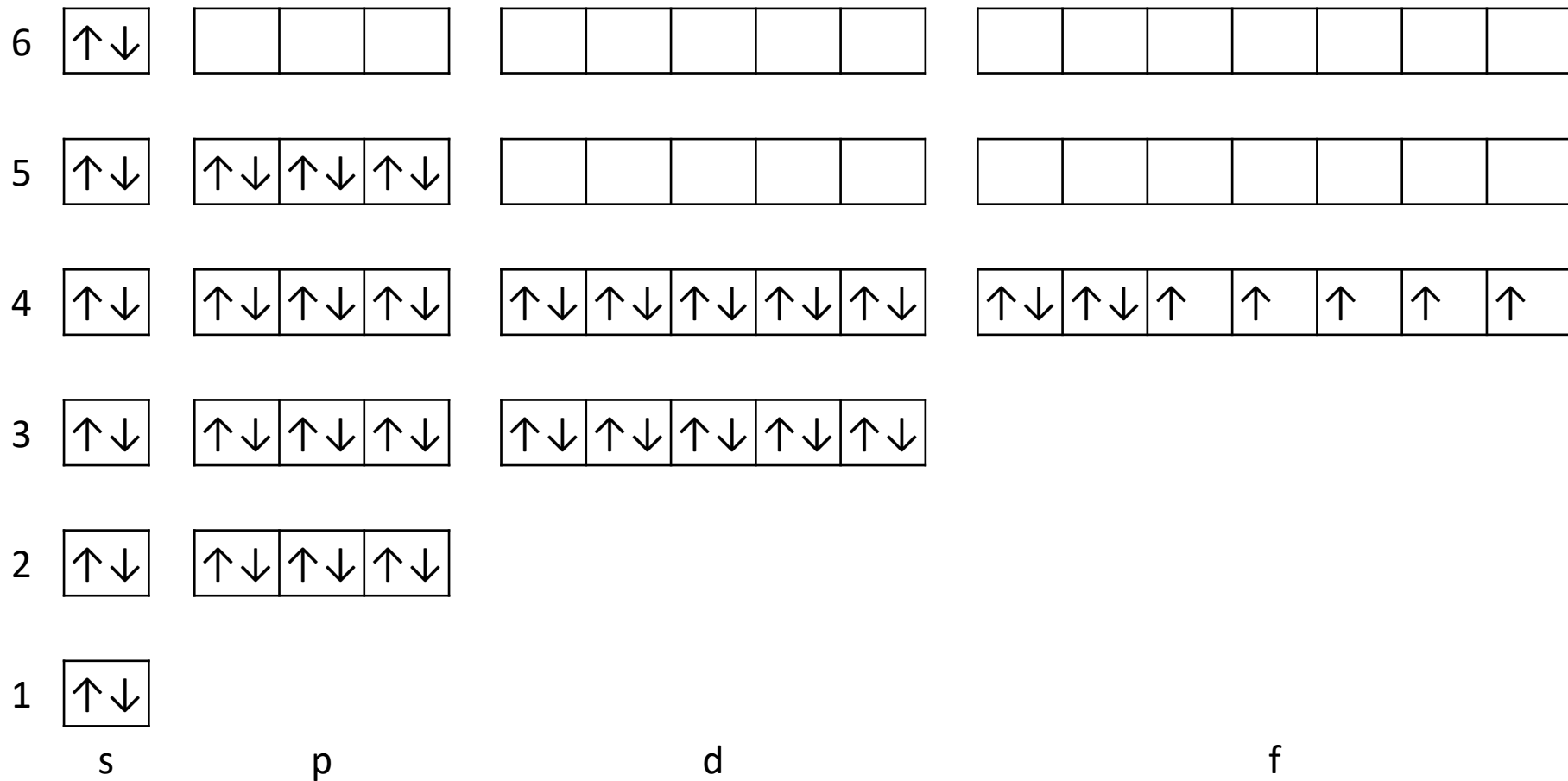
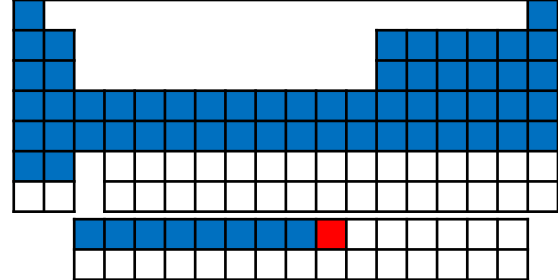

Er

[Xe]4f¹²6s²

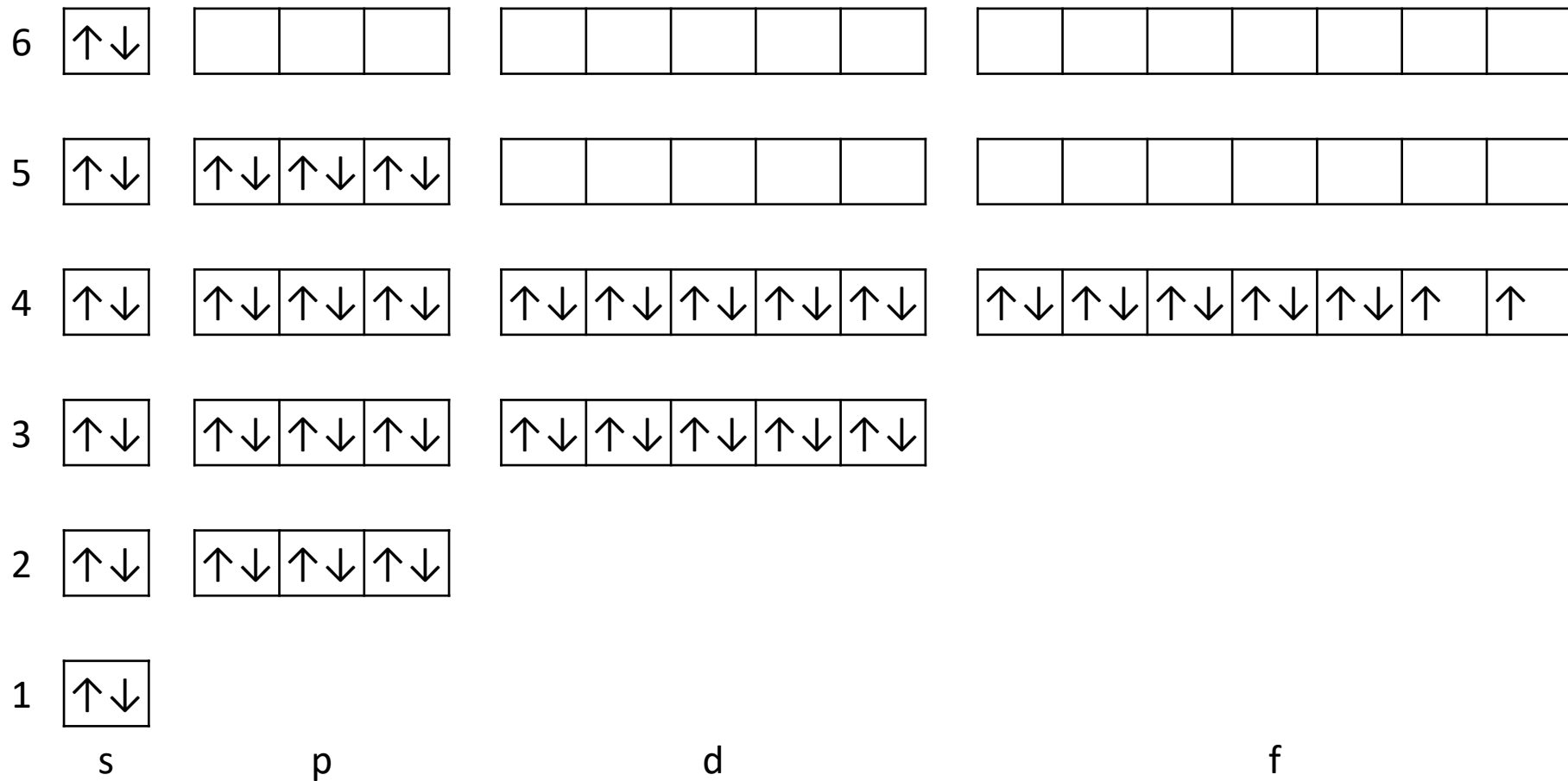
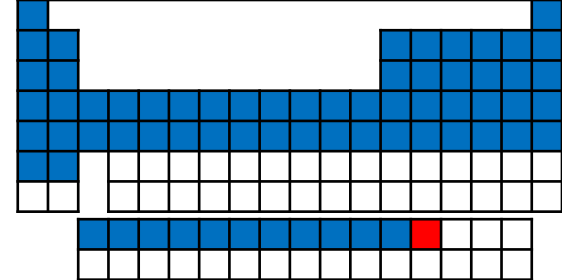

Tm

[Xe]4f¹³6s²

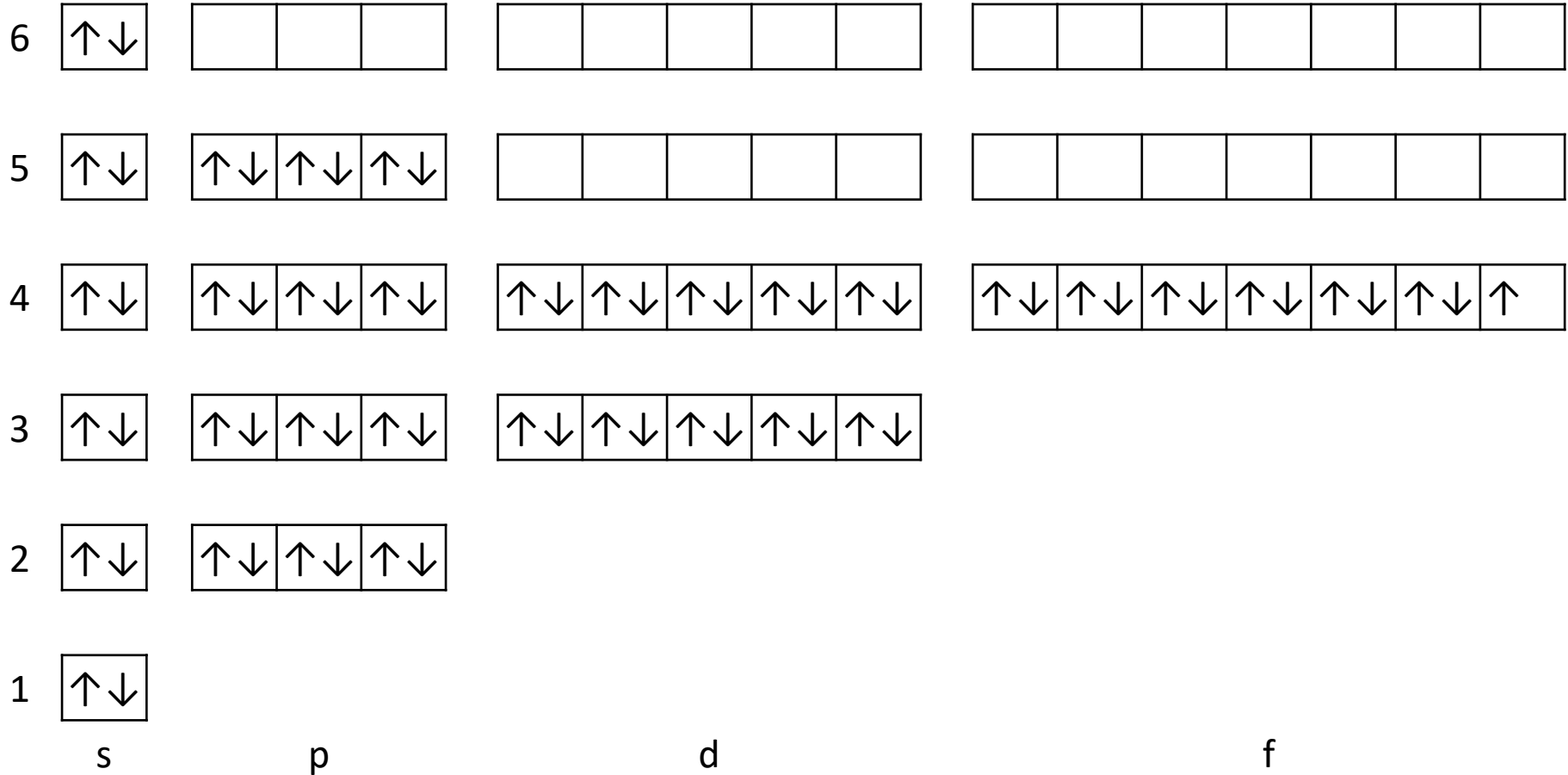
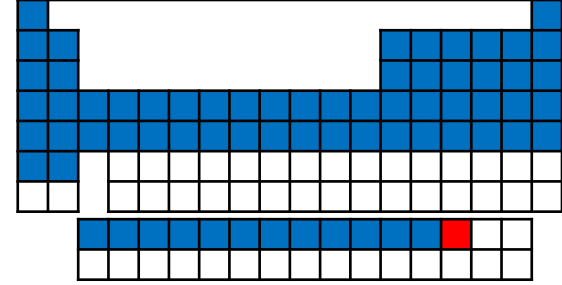

Yb

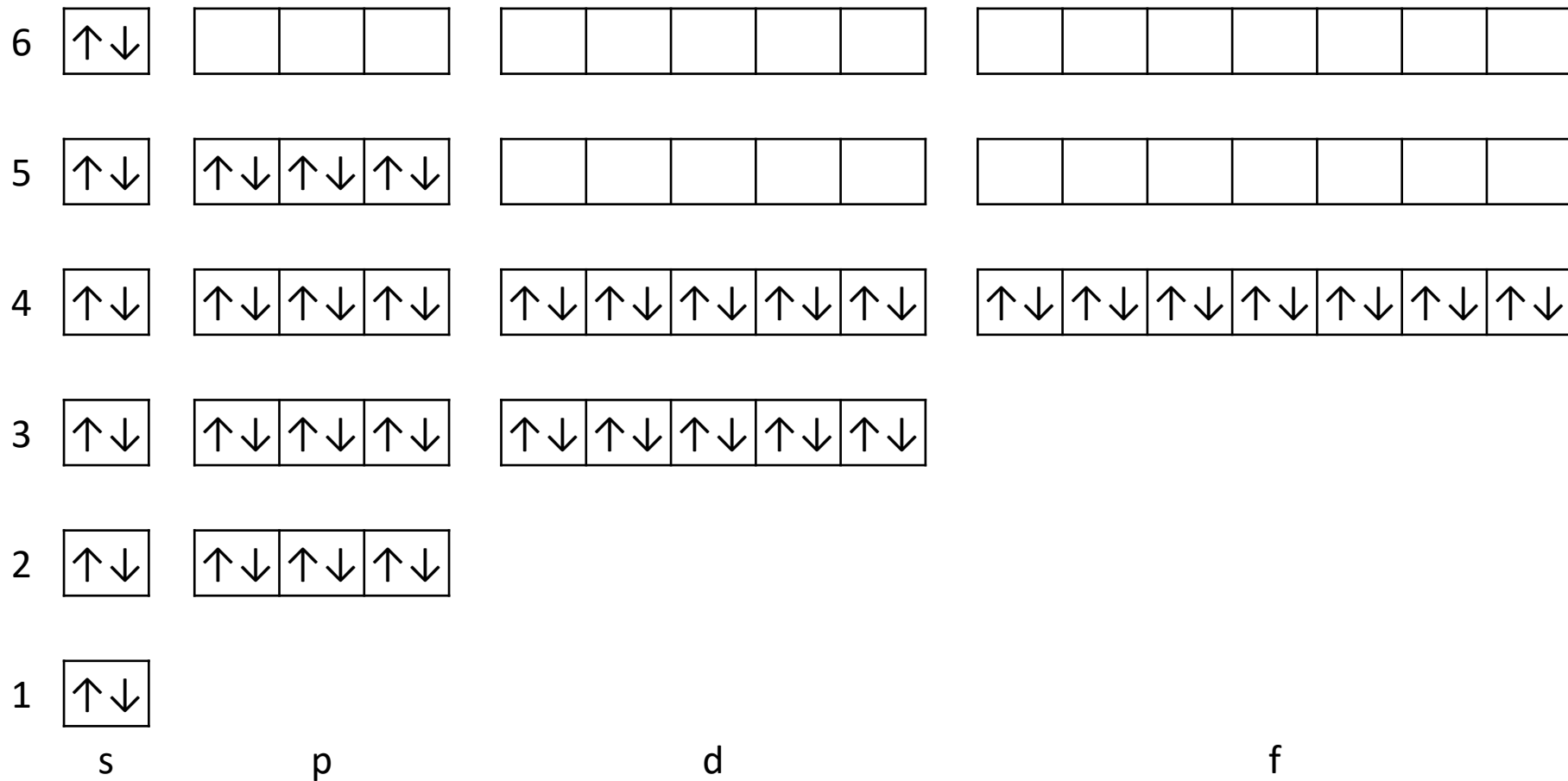
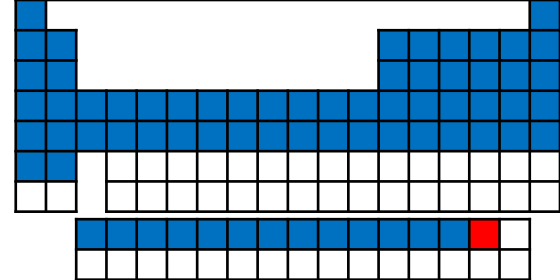
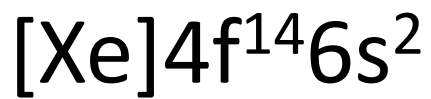

Hf

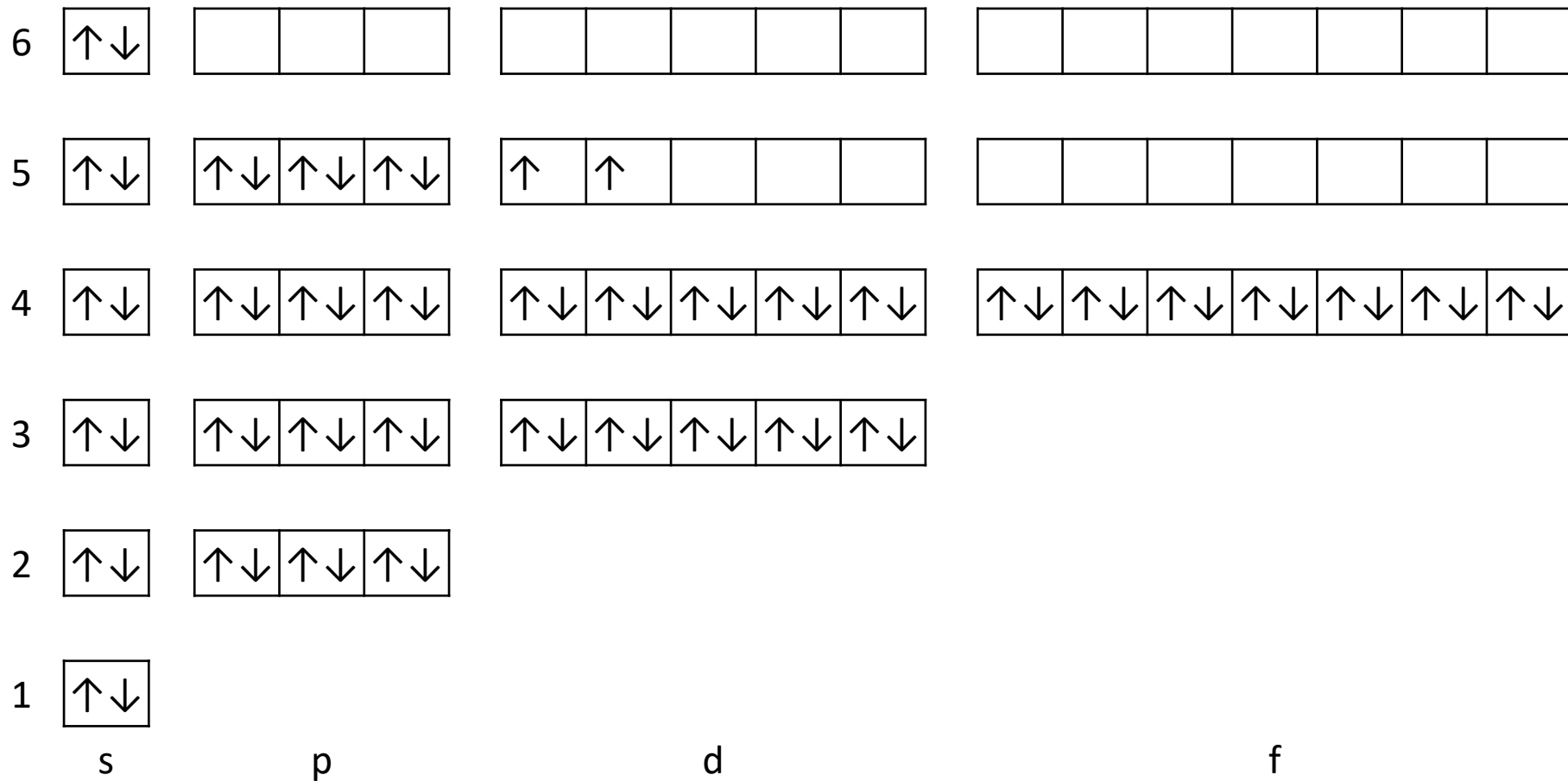
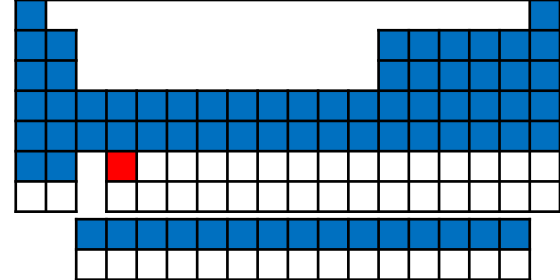
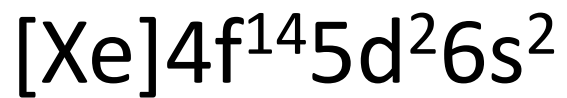

Ta

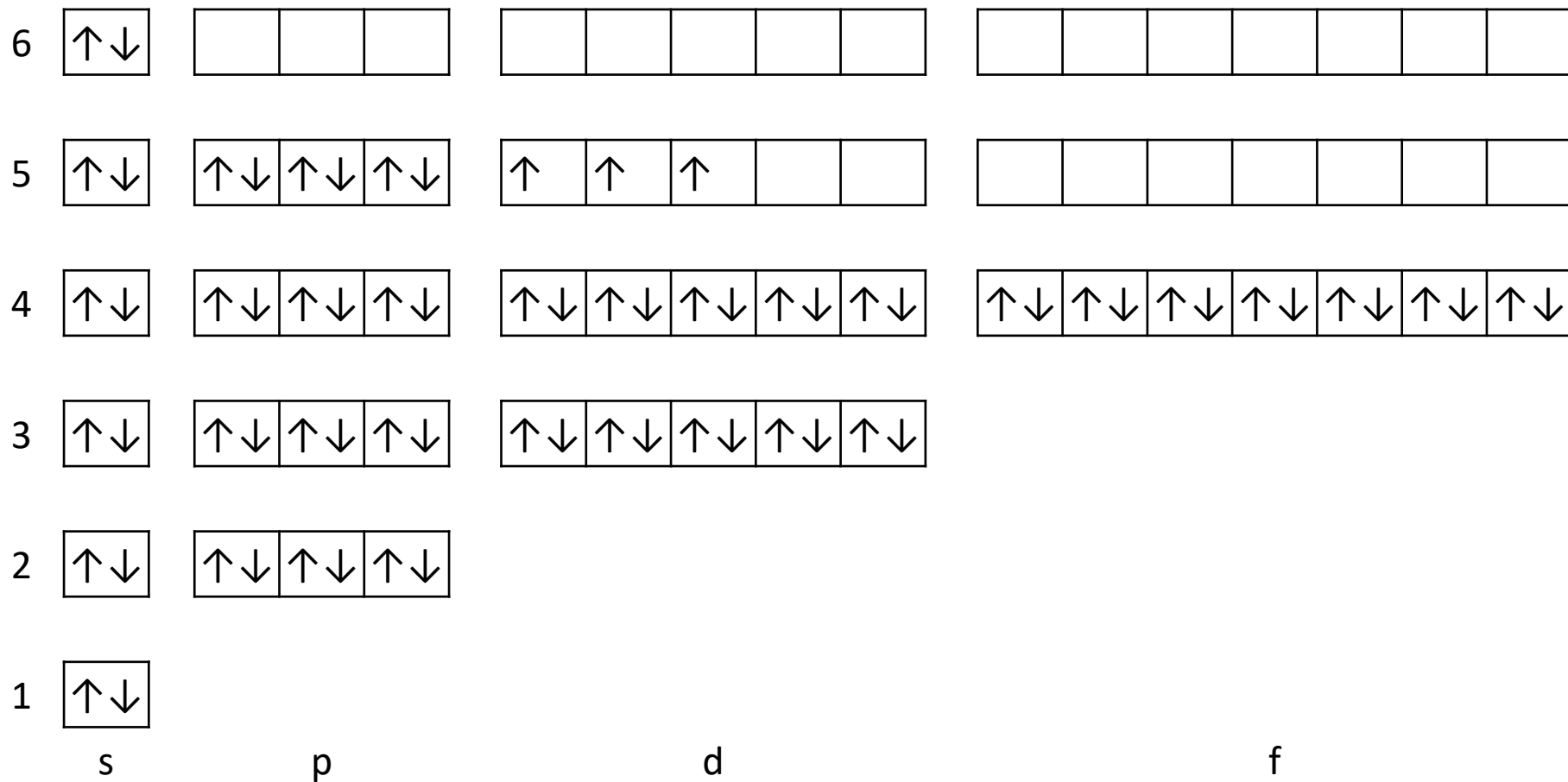
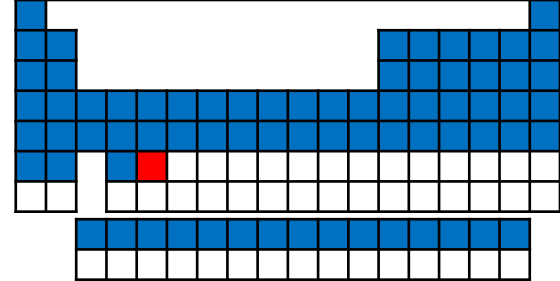
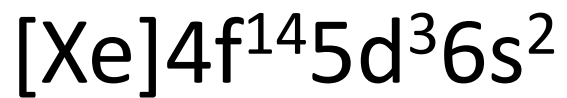

W

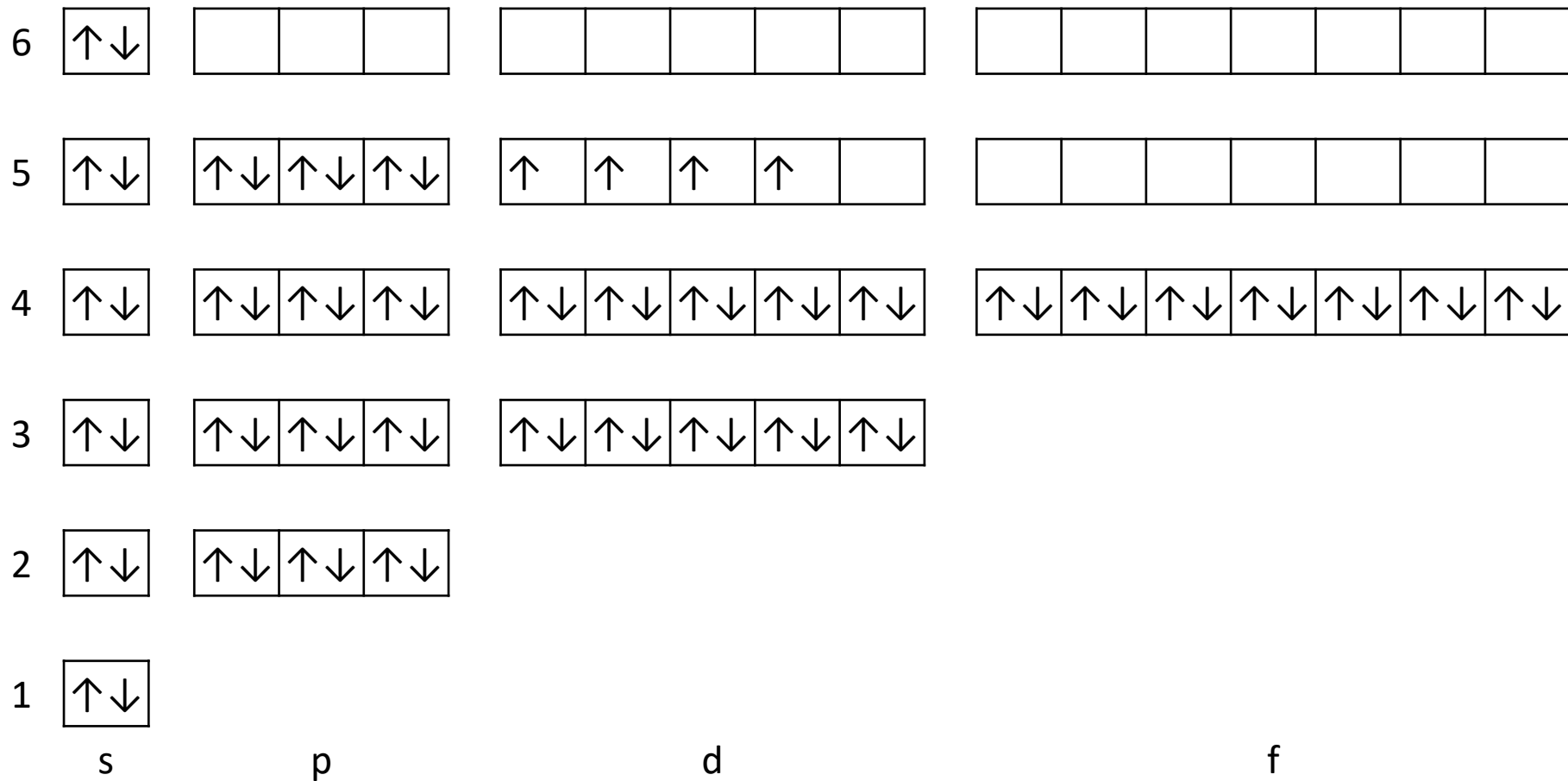
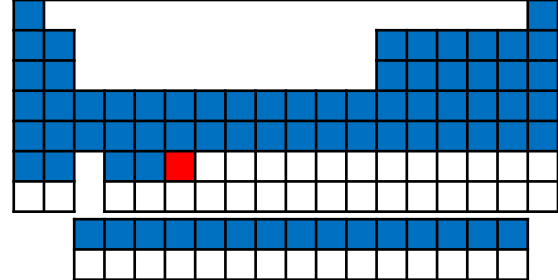
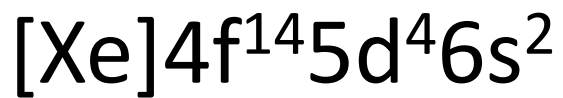

Re

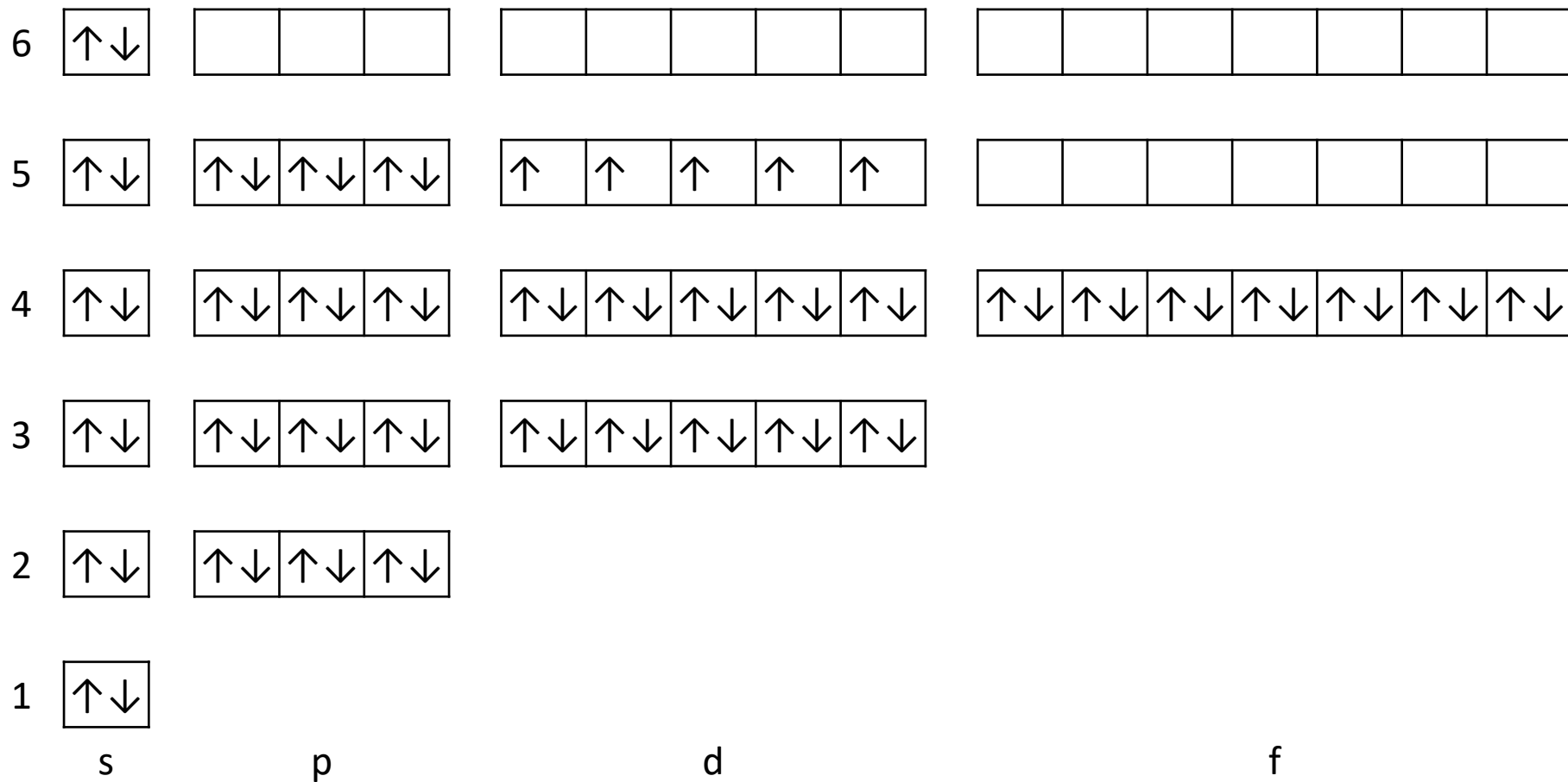
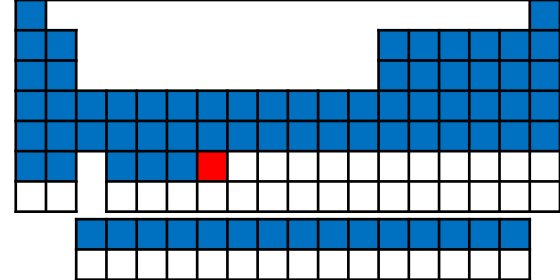
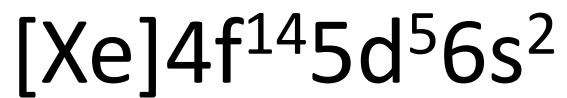

Os

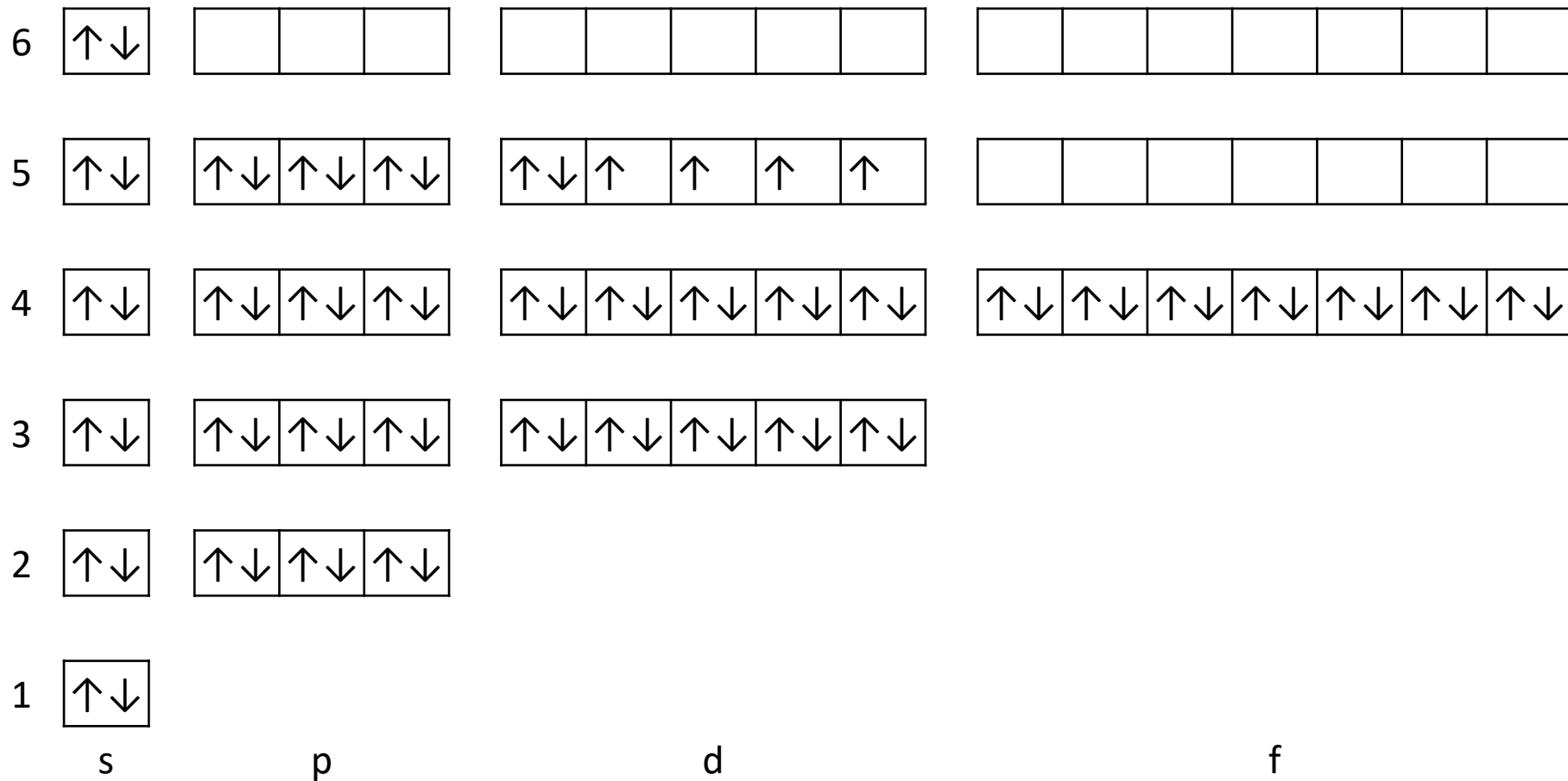
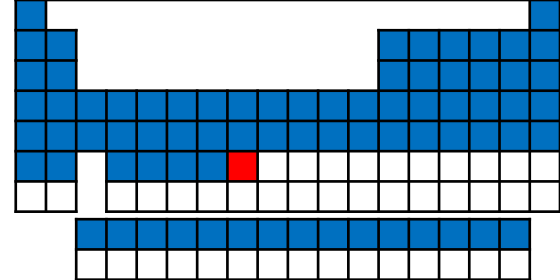
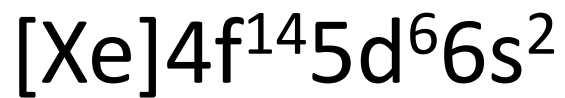

Ir

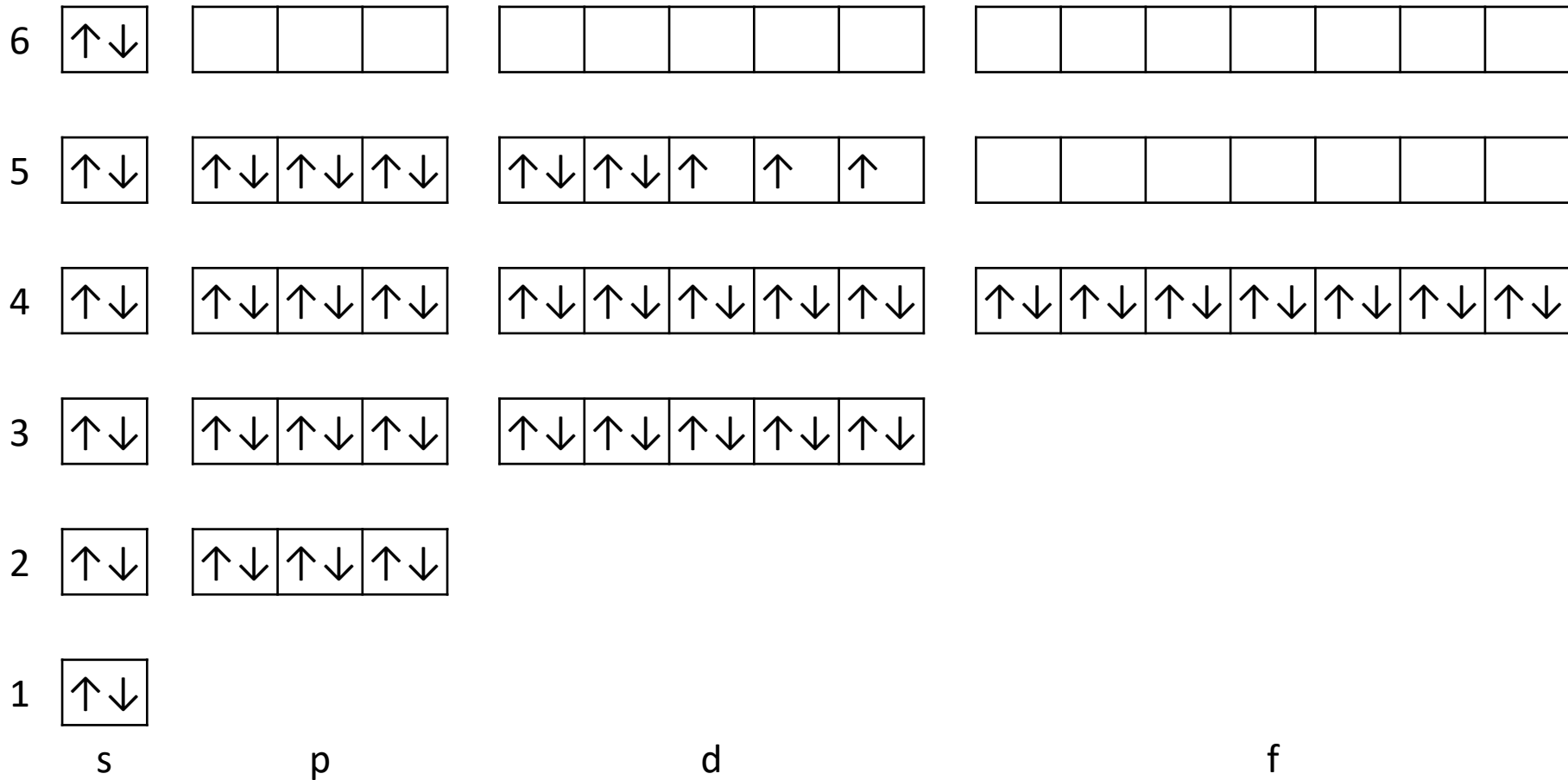
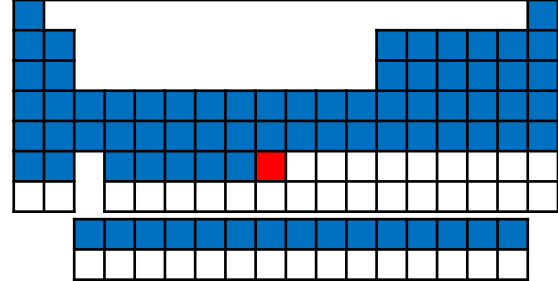
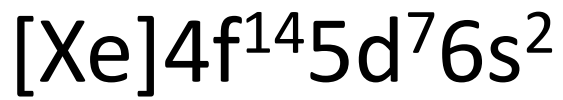

Pt

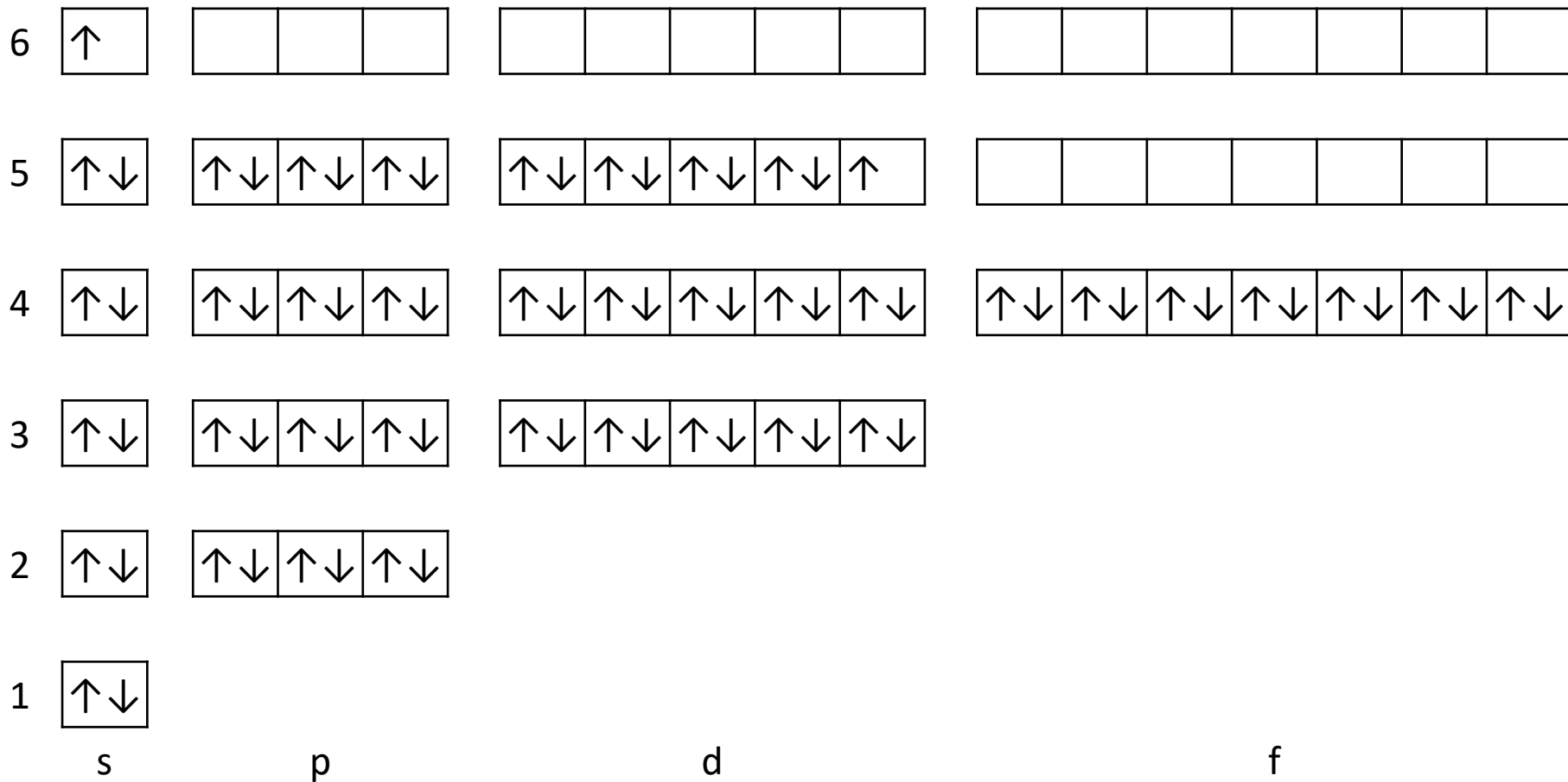
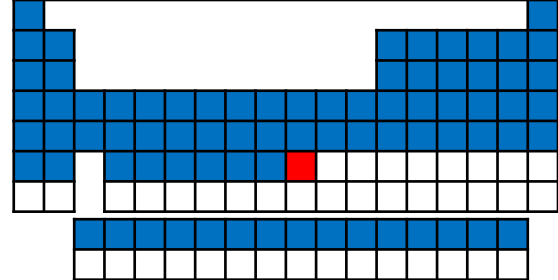
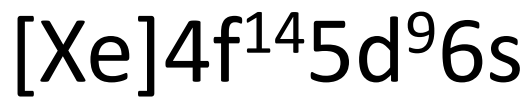

Au

[Xe]4f¹⁴5d¹⁰6s

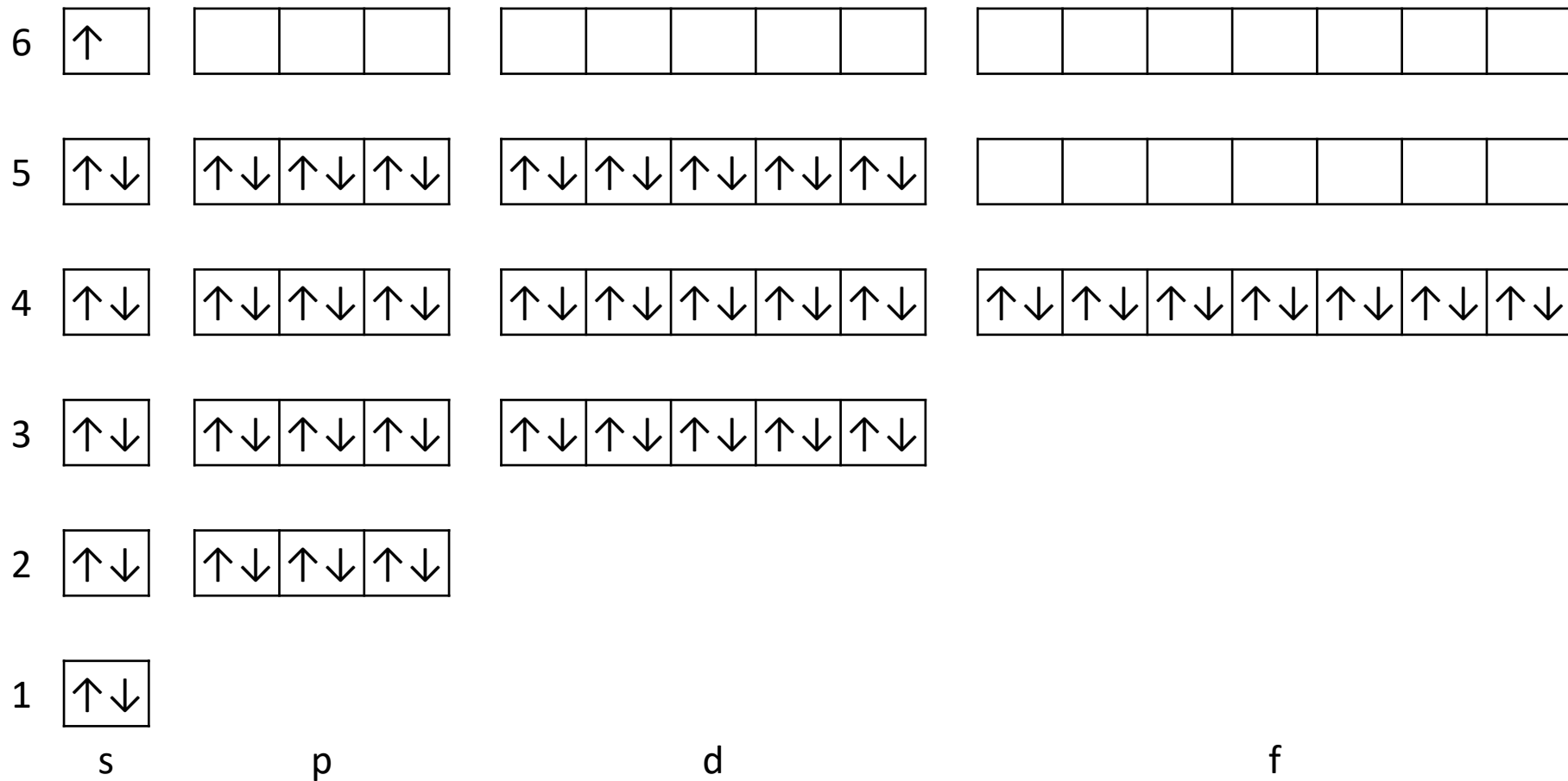
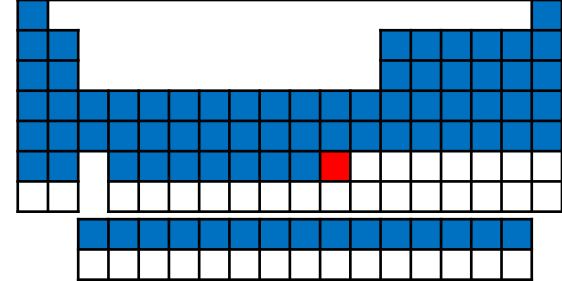

Hg

[Xe]4f¹⁴5d¹⁰6s²

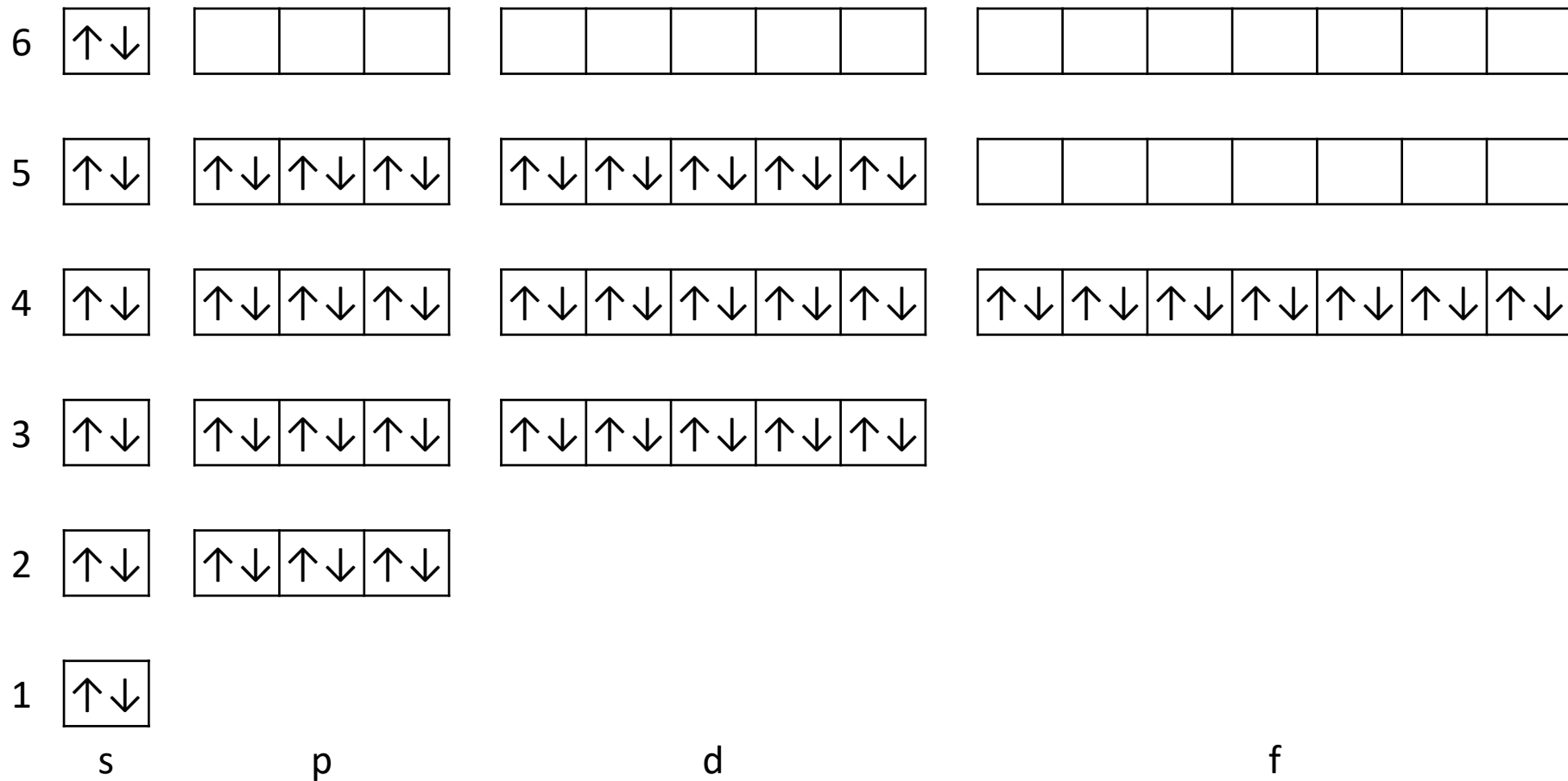
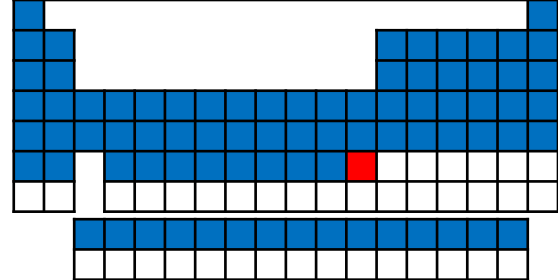

Tl

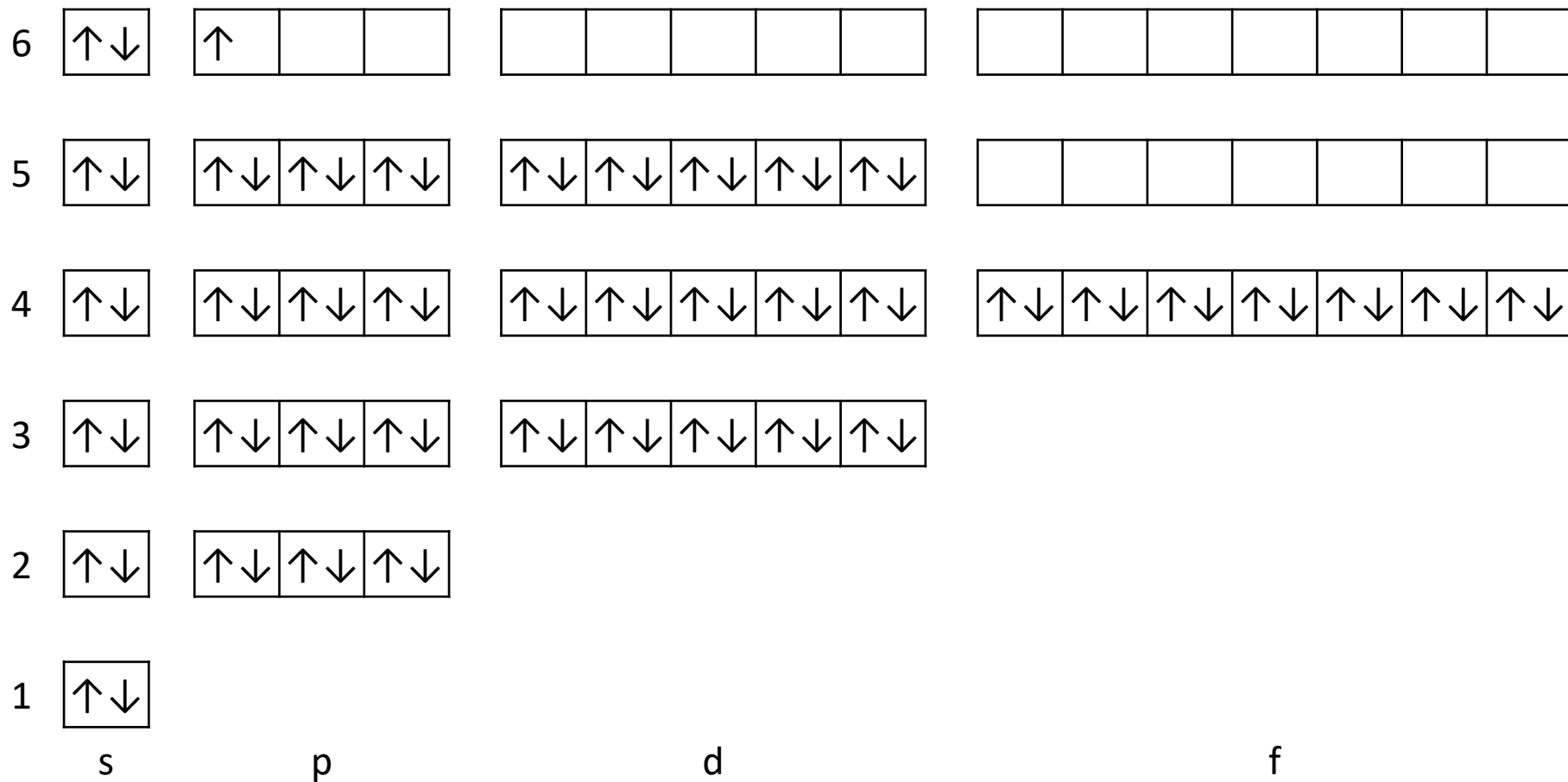
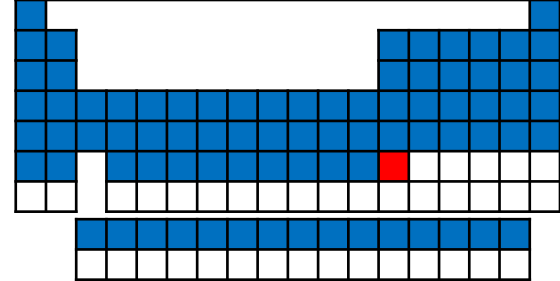
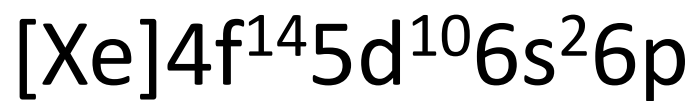

Pb

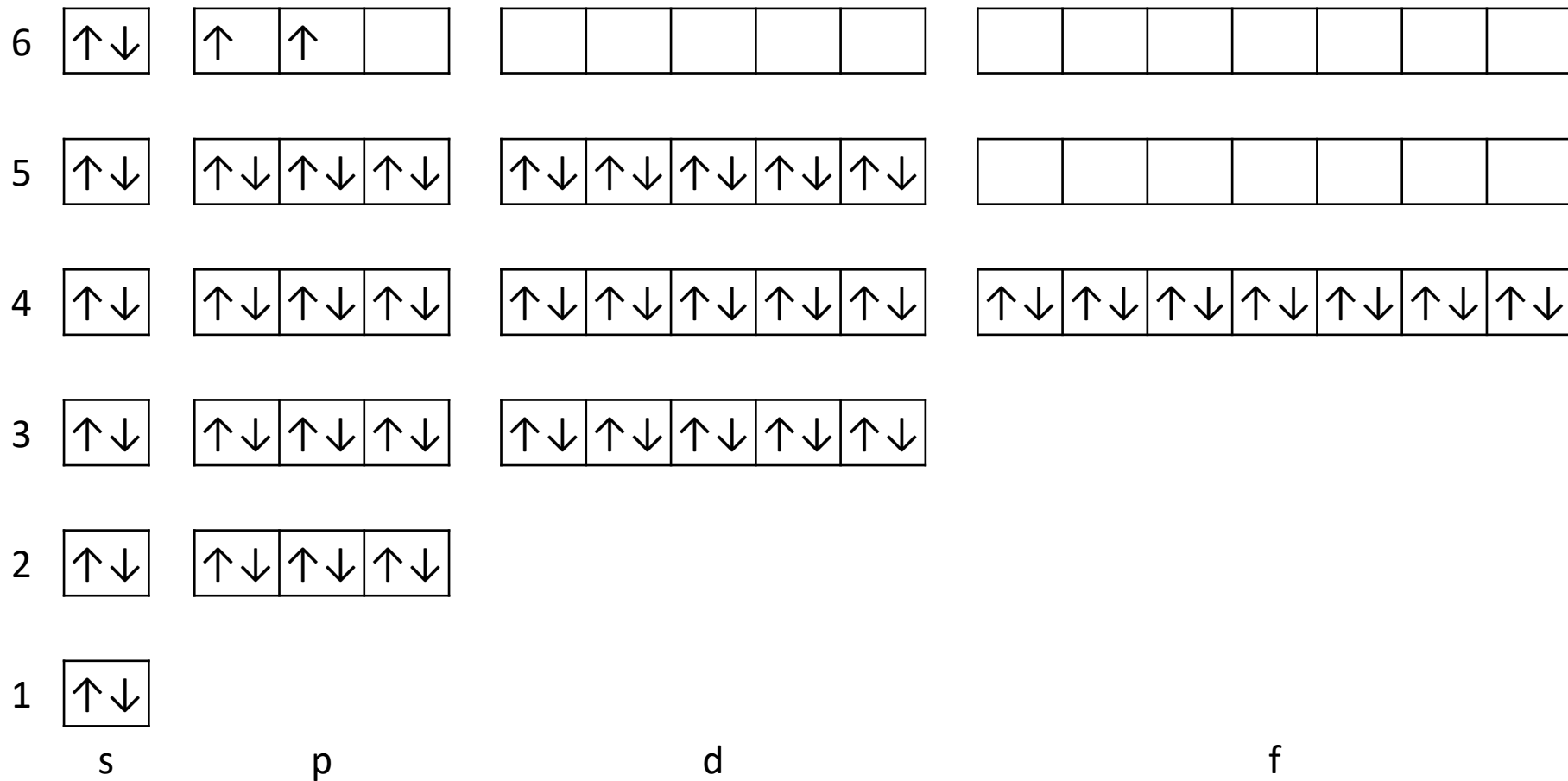
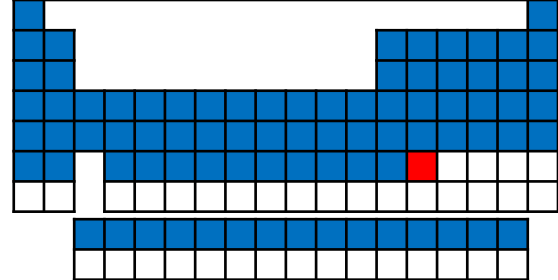

Bi

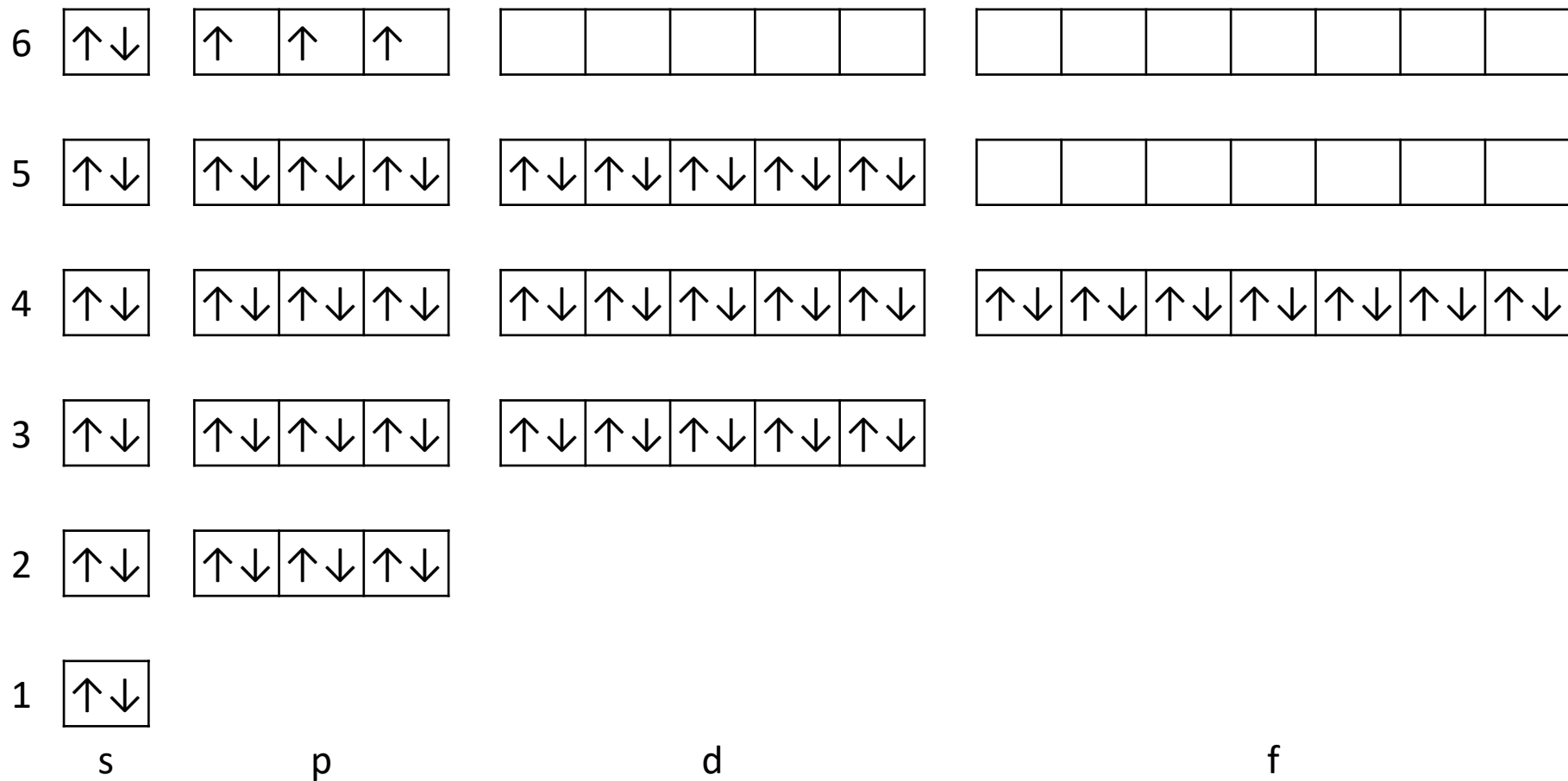
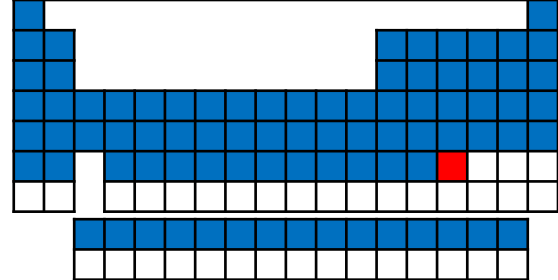

At

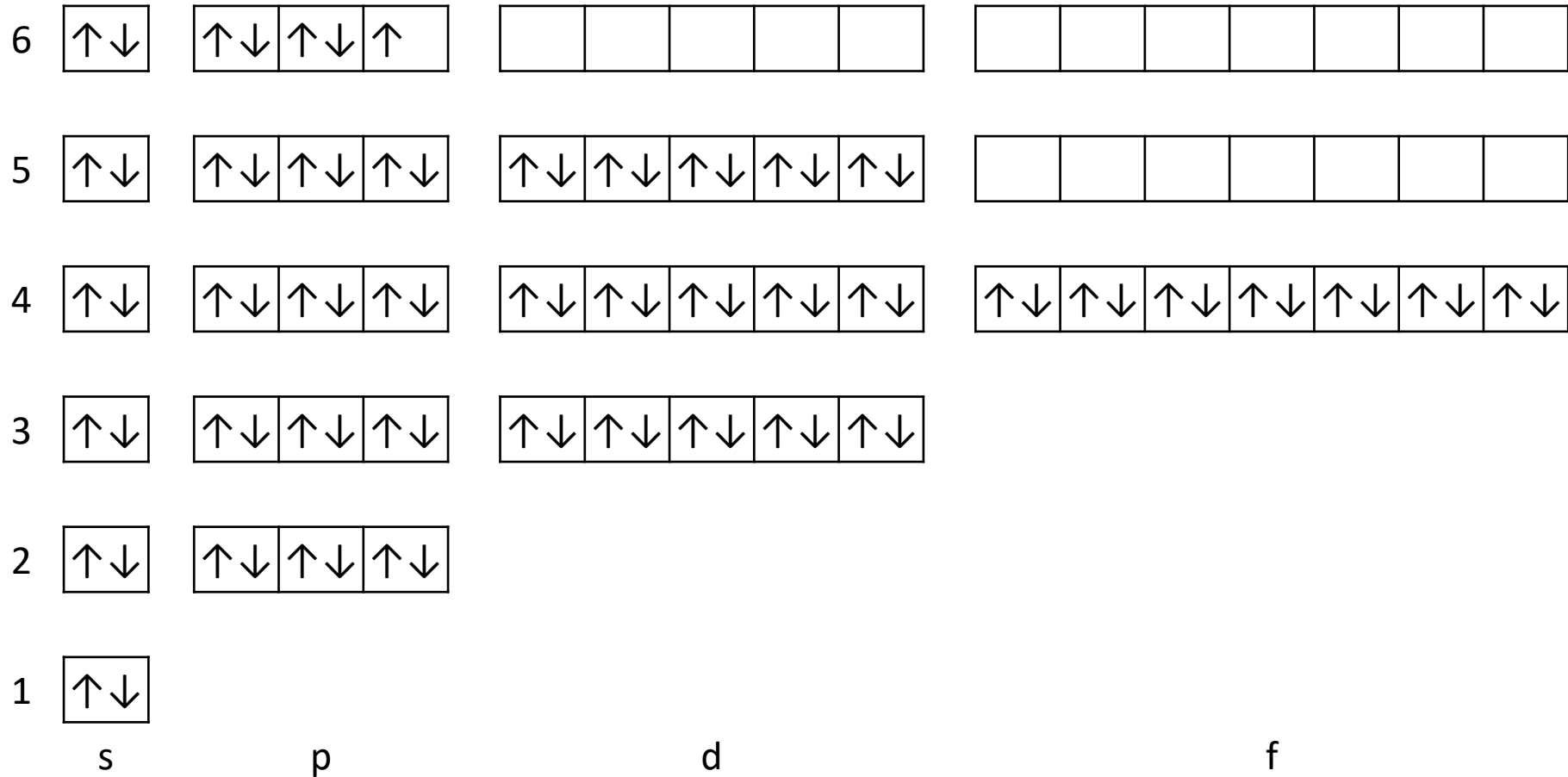
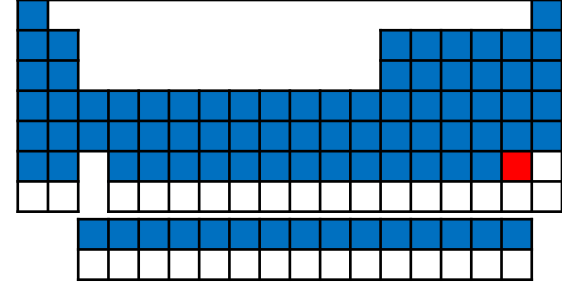
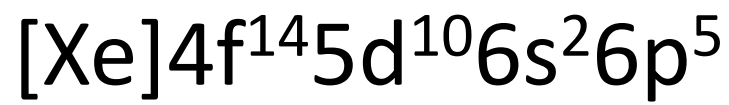

Rn

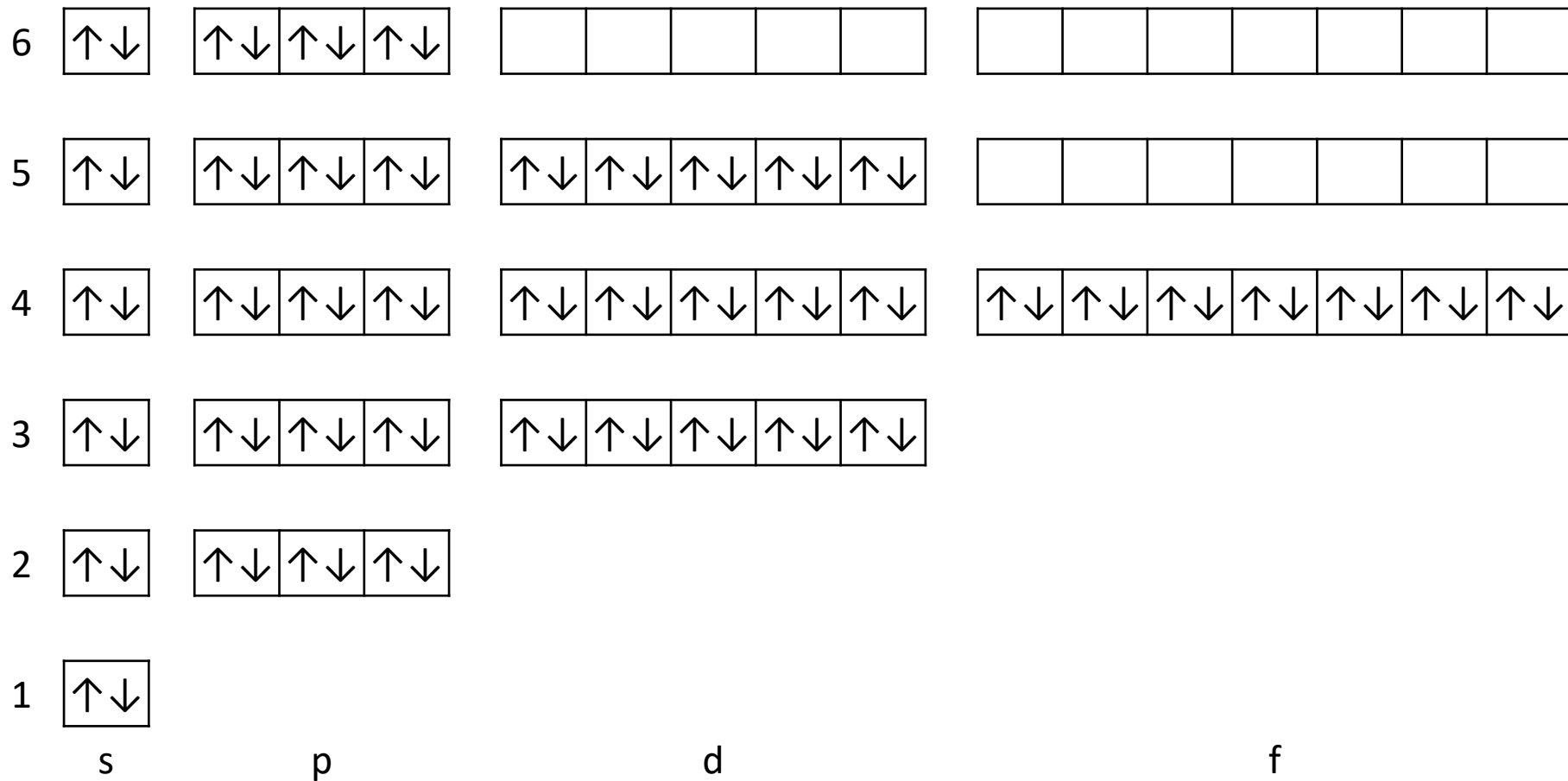
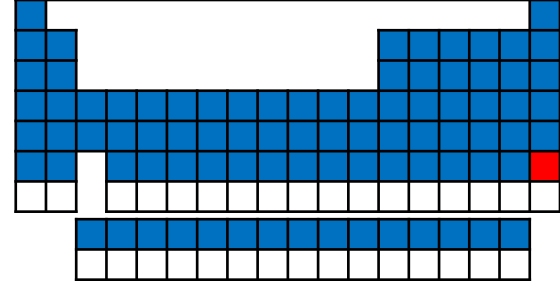

U

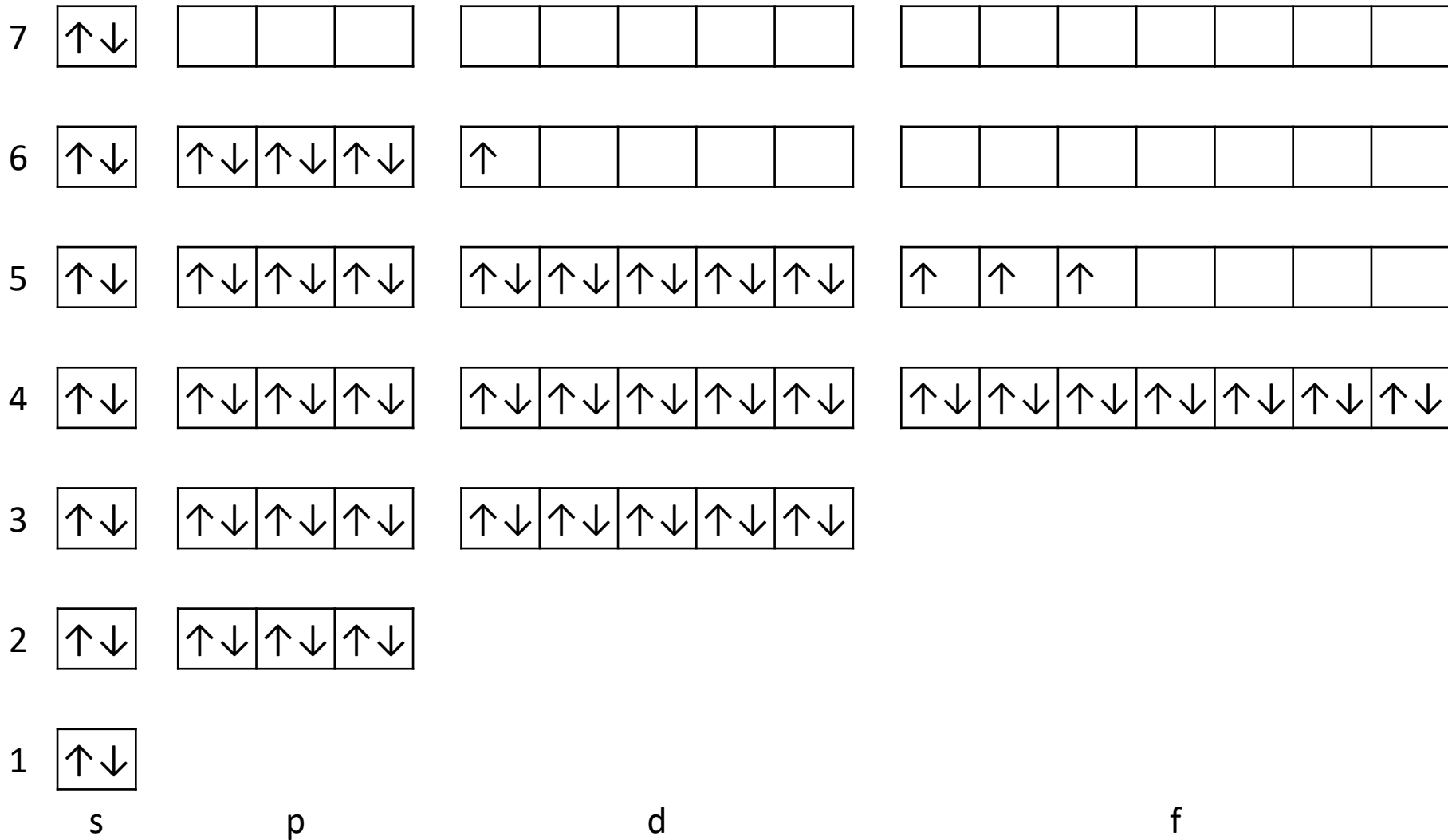
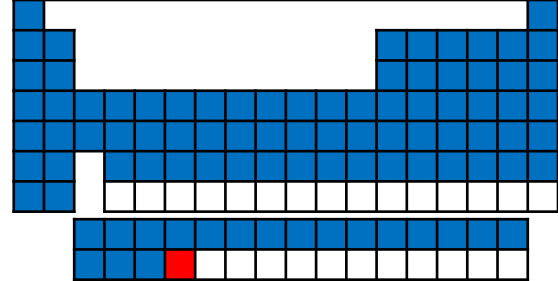

Np

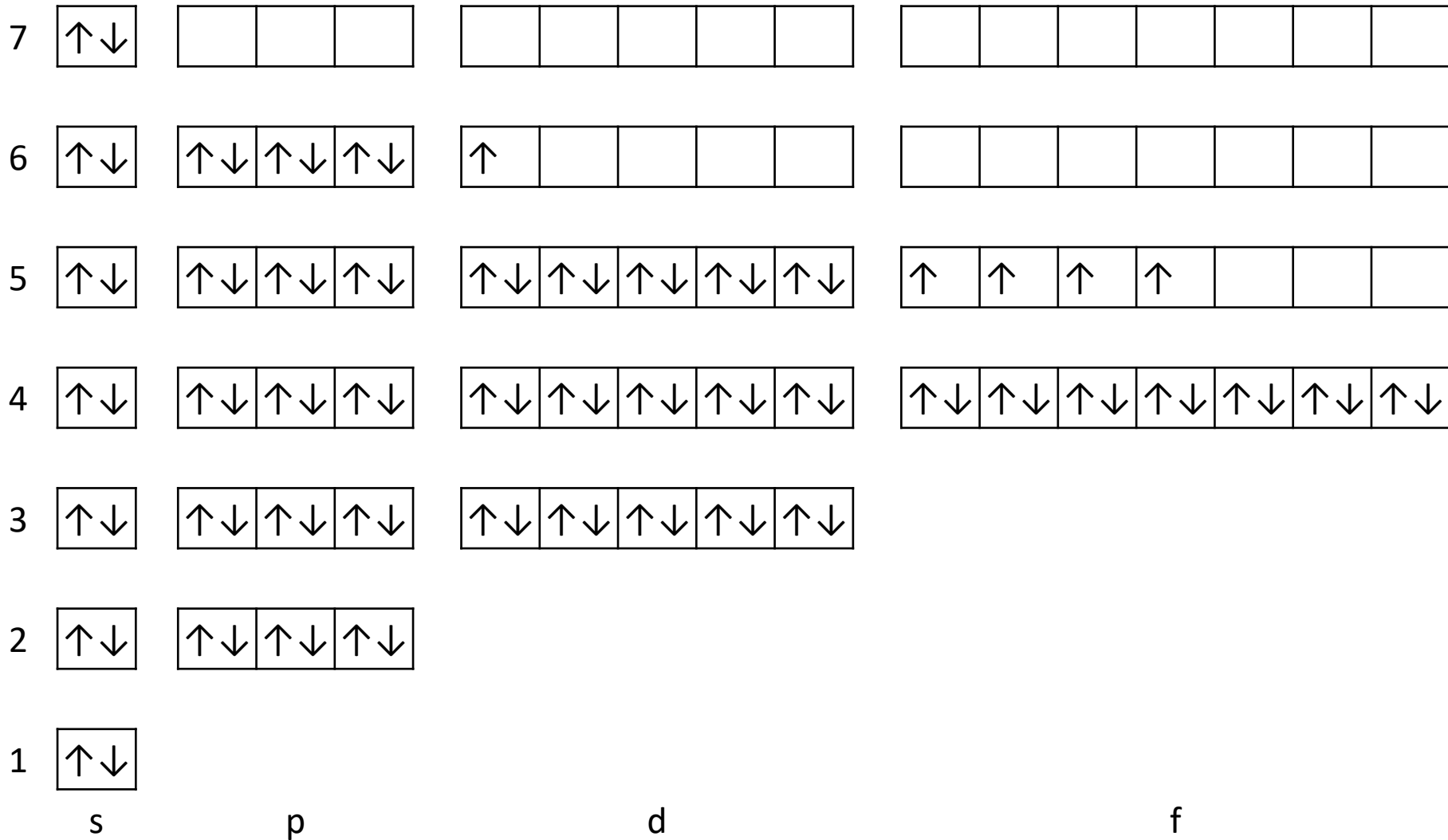
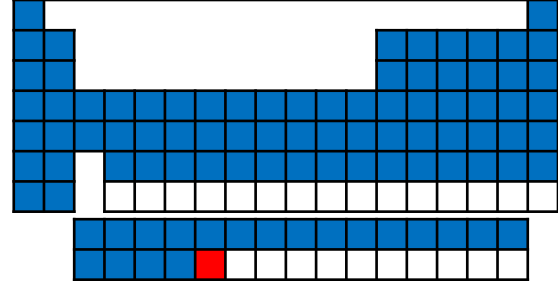
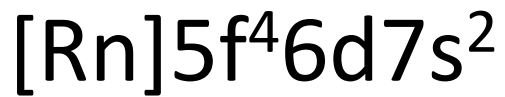

Pu

[Rn]5f⁶7s²

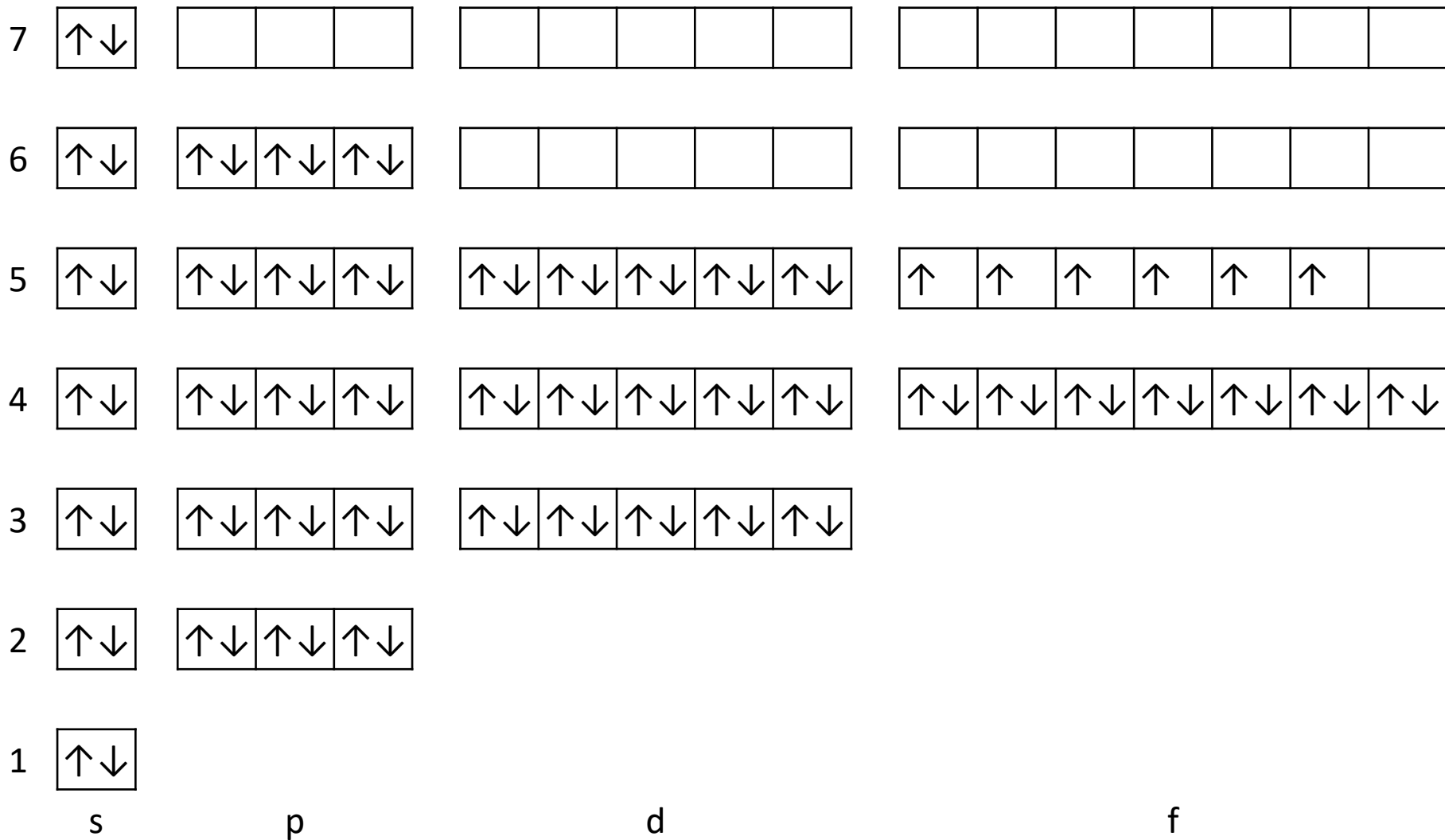
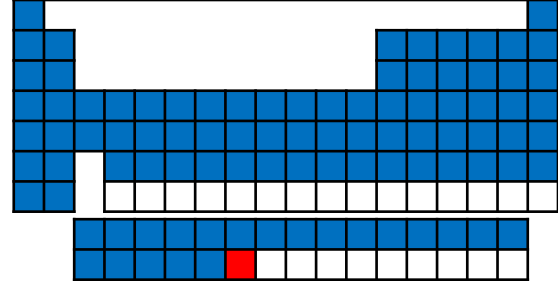

Am

[Rn]5f⁷7s²

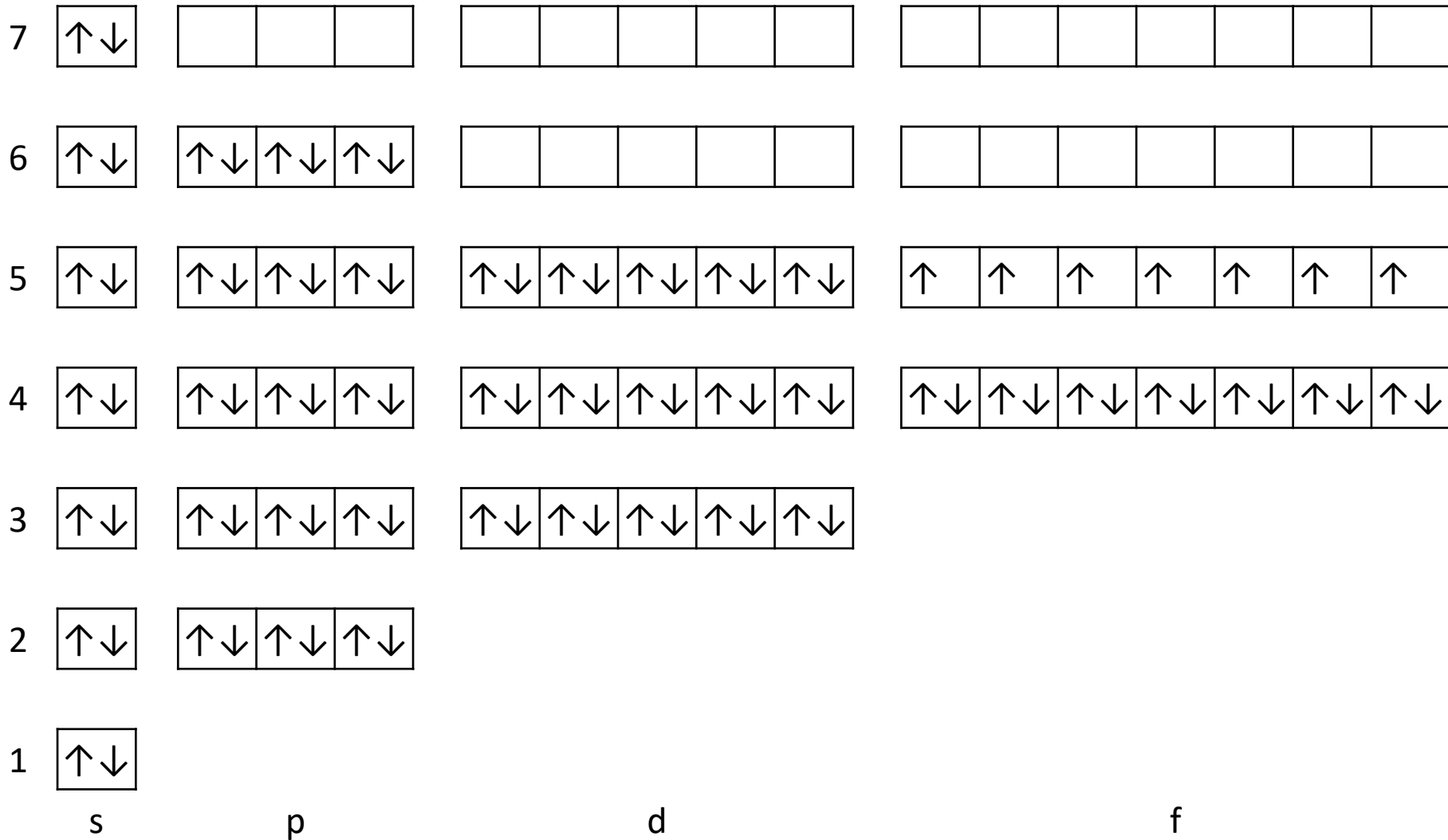
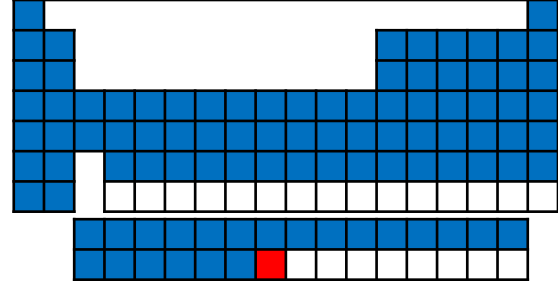

Cm

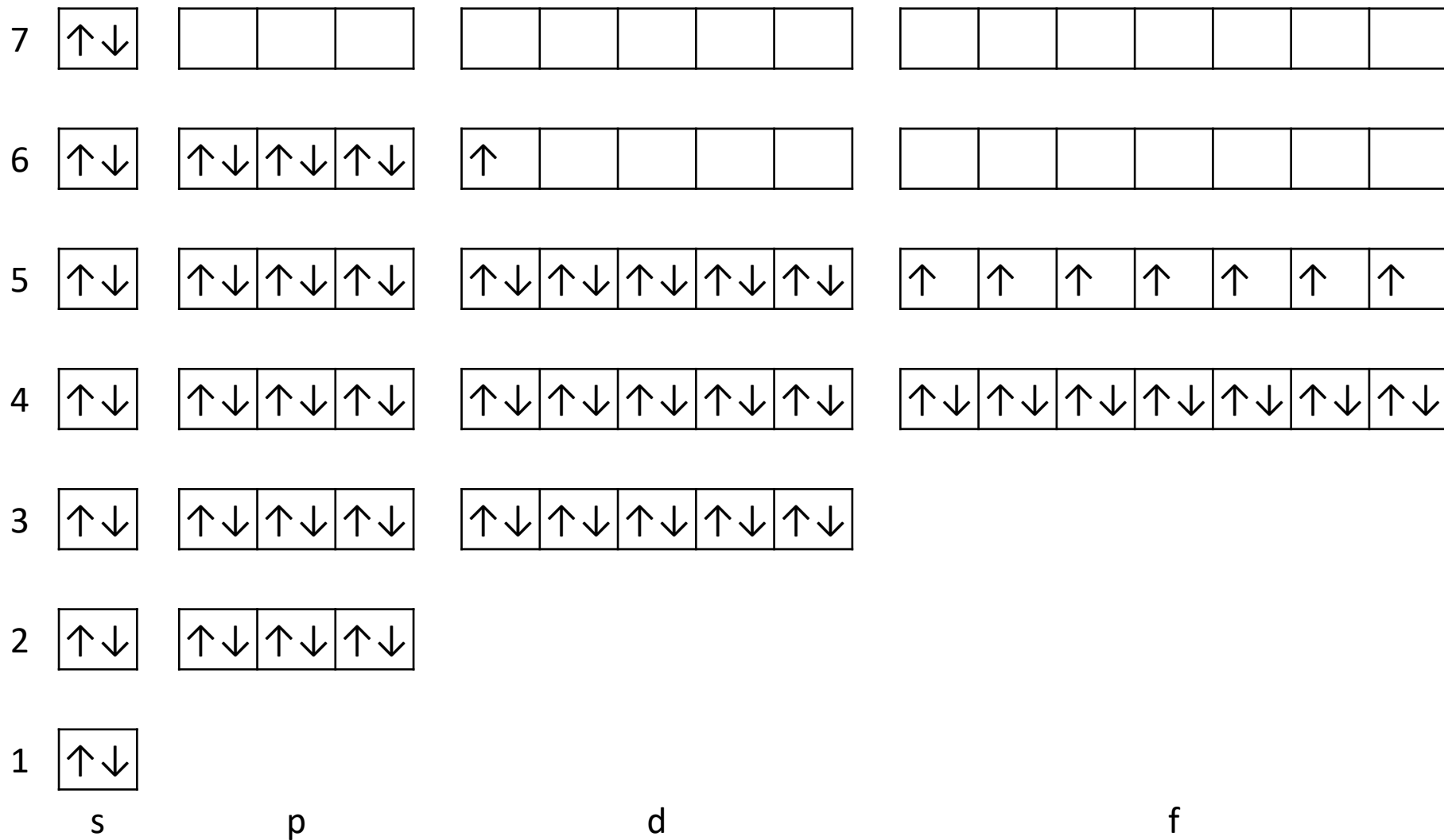
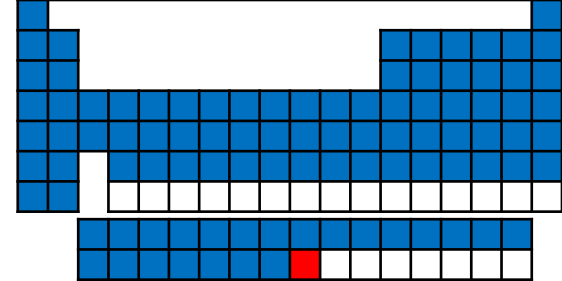
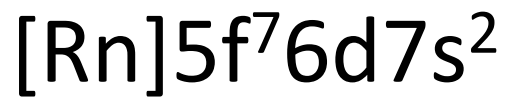

Bh

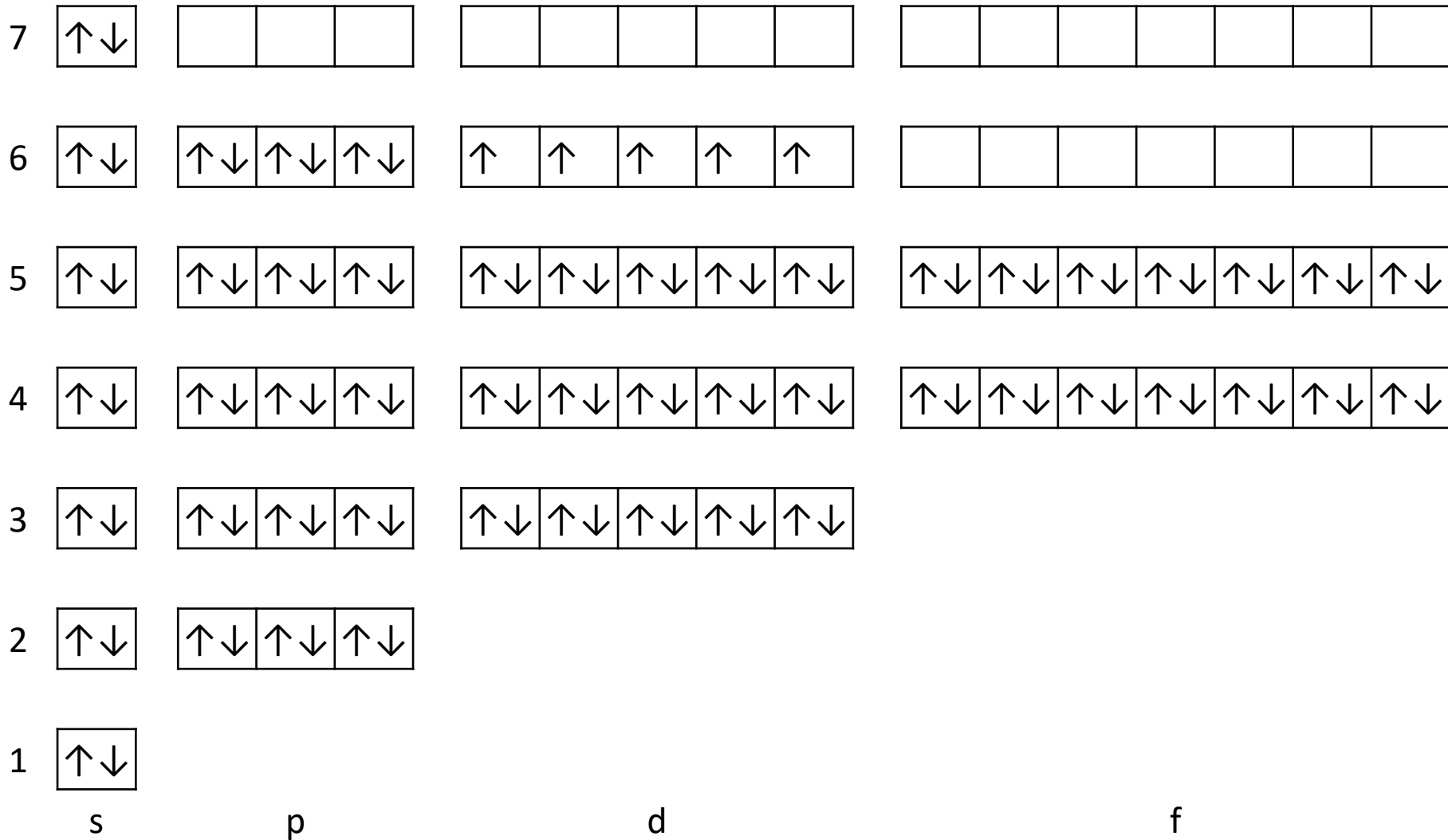
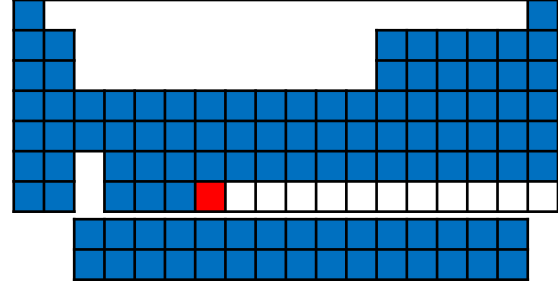
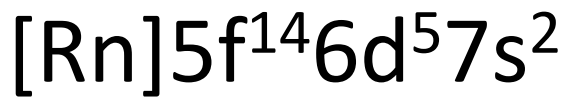

Rg

$[Rn]5f^{14}6d^{10}7s$

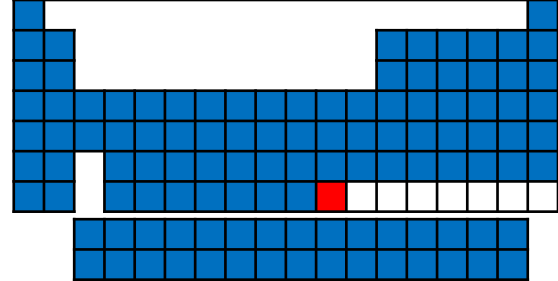

7	\uparrow																		
6	$\uparrow\downarrow$	$\uparrow\downarrow$	$\uparrow\downarrow$	$\uparrow\downarrow$	$\uparrow\downarrow$	$\uparrow\downarrow$	$\uparrow\downarrow$	$\uparrow\downarrow$	$\uparrow\downarrow$										
5	$\uparrow\downarrow$	$\uparrow\downarrow$	$\uparrow\downarrow$	$\uparrow\downarrow$	$\uparrow\downarrow$	$\uparrow\downarrow$	$\uparrow\downarrow$	$\uparrow\downarrow$	$\uparrow\downarrow$	$\uparrow\downarrow$	$\uparrow\downarrow$	$\uparrow\downarrow$	$\uparrow\downarrow$	$\uparrow\downarrow$	$\uparrow\downarrow$	$\uparrow\downarrow$	$\uparrow\downarrow$	$\uparrow\downarrow$	$\uparrow\downarrow$
4	$\uparrow\downarrow$	$\uparrow\downarrow$	$\uparrow\downarrow$	$\uparrow\downarrow$	$\uparrow\downarrow$	$\uparrow\downarrow$	$\uparrow\downarrow$	$\uparrow\downarrow$	$\uparrow\downarrow$	$\uparrow\downarrow$	$\uparrow\downarrow$	$\uparrow\downarrow$	$\uparrow\downarrow$	$\uparrow\downarrow$	$\uparrow\downarrow$	$\uparrow\downarrow$	$\uparrow\downarrow$	$\uparrow\downarrow$	$\uparrow\downarrow$
3	$\uparrow\downarrow$	$\uparrow\downarrow$	$\uparrow\downarrow$	$\uparrow\downarrow$	$\uparrow\downarrow$	$\uparrow\downarrow$	$\uparrow\downarrow$	$\uparrow\downarrow$	$\uparrow\downarrow$	$\uparrow\downarrow$	$\uparrow\downarrow$	$\uparrow\downarrow$	$\uparrow\downarrow$	$\uparrow\downarrow$	$\uparrow\downarrow$	$\uparrow\downarrow$	$\uparrow\downarrow$	$\uparrow\downarrow$	$\uparrow\downarrow$
2	$\uparrow\downarrow$	$\uparrow\downarrow$	$\uparrow\downarrow$	$\uparrow\downarrow$															
1	$\uparrow\downarrow$																		
	s	p			d					f									

Fl

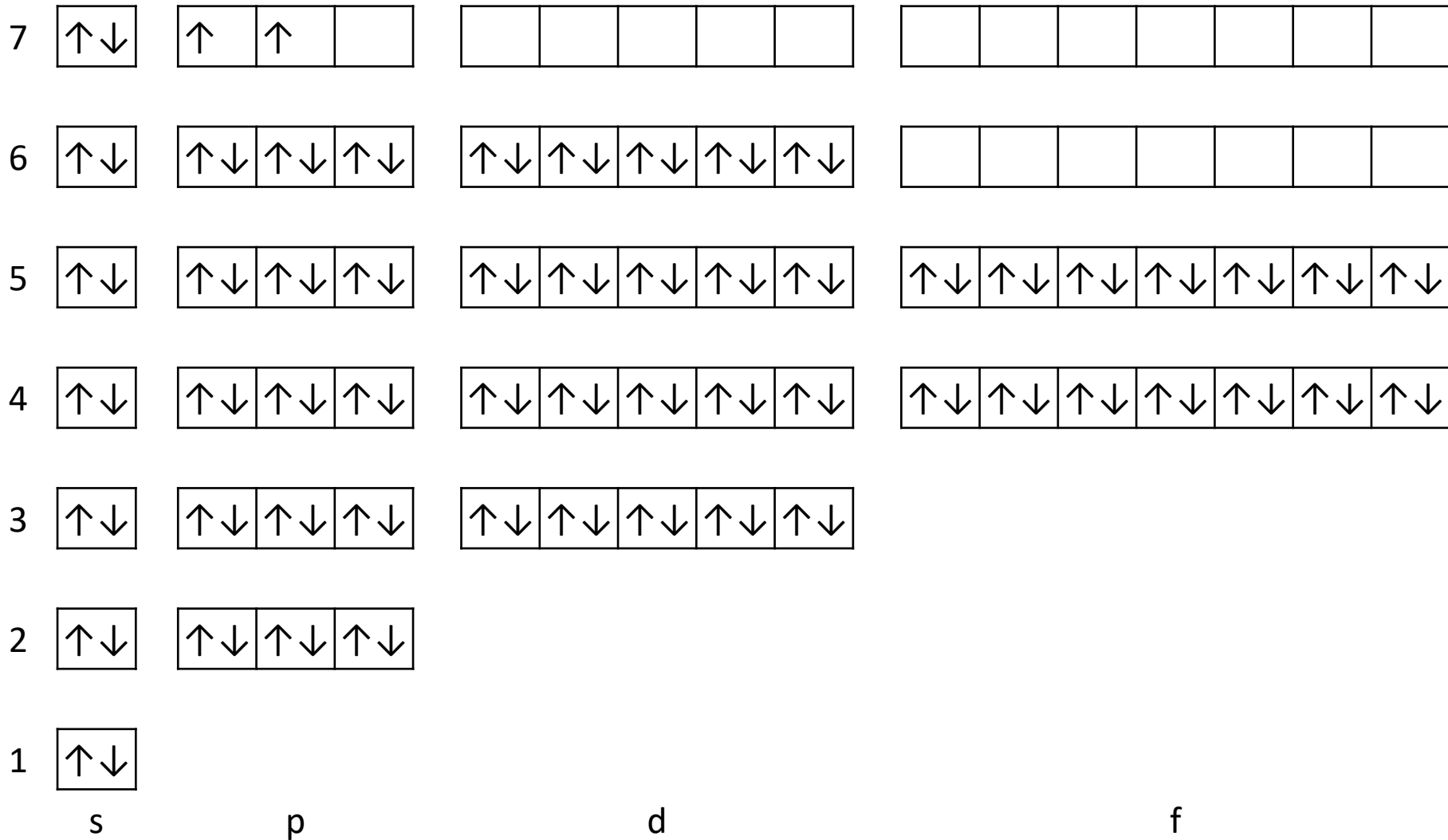
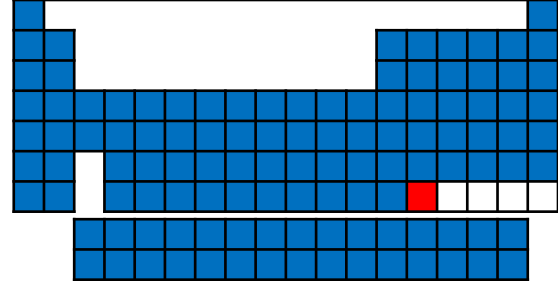
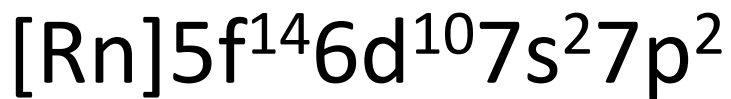

Og

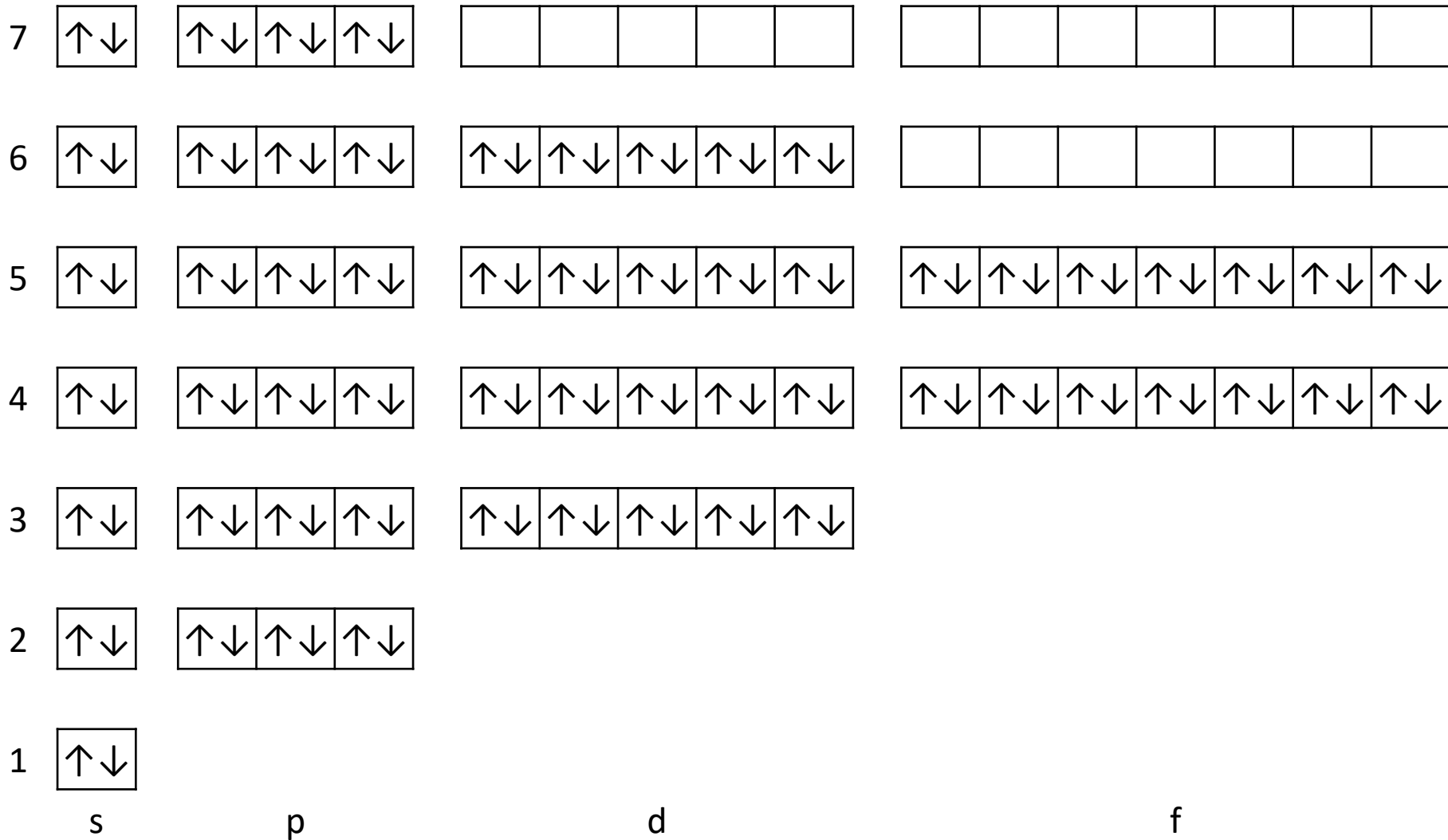
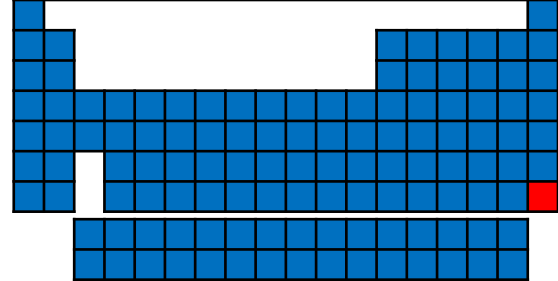
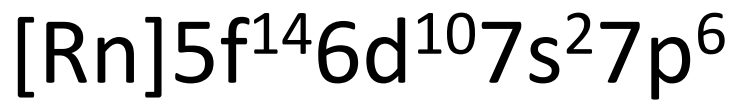

Aufbauprinzip (ohne Ausnahmen)

Regeln (nach Madelung):

- Orbitale mit kleinerem $n+l$ werden zuerst gefüllt
- bei gleichem $n+l$ werden Orbitale mit kleinerem n zuerst gefüllt

1s

2s

2p

3s

3p

4s

3d

4p

5s

4d

5p

6s

4f

5d

6p

7s

5f

6d

7p

Blöcke des Periodensystems der Elemente

<- 1s			1s ->
<- 2s ->			<- 2p ->
<- 3s ->			<- 3p ->
<- 4s ->	<- 3d ->		<- 4p ->
<- 5s ->	<- 4d ->		<- 5p ->
<- 6s ->	<- 5d ->		<- 6p ->
<- 7s ->	<- 6d ->		<- 7p ->

<- 4f ->
<- 5f ->